

# INTRODUCTION TO MASS COMMUNICATION

MASS COMMUNICATION  
COMPLEMENTARY COURSE FOR BA ENGLISH

(2011 Admn. Onwards)

SEMESTER II



**UNIVERSITY OF CALICUT**

**SCHOOL OF DISTANCE EDUCATION**

CALICUT UNIVERSITY.P.O., MALAPPURAM, KERALA,INDIA – 673 635

391

**UNIVERSITY OF CALICUT  
SCHOOL OF DISTANCE EDUCATION**

STUDY MATERIAL

II Semester

MASS COMMUNICATION  
COMPLEMENTARY COURSE FOR BA ENGLISH

**INTRODUCTION TO MASS COMMUNICATION**

Prepared and Scrutinised by

*Dr. Muhammadali. N,  
Reader and Head,  
Department of Journalism and Mass Communication,  
University of Calicut.*

Layout & Settings  
Computer Section, SDE

©  
Reserved

## **CONTENTS**

<b>MODULE I</b>	<b>FUNDAMENTALS OF COMMUNICATION</b>	<b>05-16</b>
<b>MODULE II</b>	<b>DEFINING MASS COMMUNICATION</b>	<b>17-23</b>
<b>MODULE III</b>	<b>PRINT MEDIA</b>	<b>24-40</b>
<b>MODULE IV</b>	<b>ELECTRONIC MEDIA</b>	<b>41-55</b>
<b>MODULE V</b>	<b>NEW MEDIA</b>	<b>56-61</b>



# MODULE I

## FUNDAMENTALS OF COMMUNICATION

### Objectives

After completing this unit, you should be familiar with

- The meaning and importance of the concept of communication
- Various definitions of communication
- The elements of communication
- The nature and purpose of communication
- The functions of communication
- Various types of communication
- Various models of communication

### Introduction

It is impossible not to communicate. Everybody communicates, everything communicates. Communication is not a process limited to human beings only. All creatures on the earth, from worms to humans, are communicating each other for their better existence. It is a universal phenomenon.

Communication is a process which includes transmission of information, ideas, emotions, skills, knowledge by using symbols, words, gestures, and visuals and so on. Thus, the act of communication is referred to as 'transmission'.

As communication being a universal phenomenon that defines all human behavior, it is important to have a clear understanding of the concepts of communication. What is communication? Why is it important to human beings? How does it work? What are the elements involved in the process of communication? How do they relate each other? What are the different types of communication? We should answer these questions to have a better understanding of the subject. Let us look into each of them.

### Meaning of Communication

The word communication was originated from the Latin word '*communis*' which means '*common*'. Communion, community, communism, commonality, communalism etc. are some related words having the same linguistic roots. Similarly, newer and newer terms are being coined as the concept of communication assumes importance day by day. Communication technology, communication media, communication age, communication management are just a few.

As the very term indicates, the ultimate aim of the communication process is to create commonness between communicator and receiver of the message. Through communication, both communicator and receiver enter into a mental agreement. Thus, they achieve their goal, which may be expression of an emotion or transmission of an idea.

Transaction, interchange, interaction, dialogue, discussion, sharing, contact are some of the concepts that come up in our minds when we refer to 'communication'.

According to Oxford English Dictionary, communication is 'the transfer or conveying of meaning' (Oxford Dictionary).

### **Definitions**

1. Communication is the exchange of meanings between individuals through a common system of symbols. (I.A.Richards).
2. The transmission of information, ideas attitudes, or emotion from one person or group to another or others primarily through symbols.  
(Theodorson and Theodorson)
3. Communication is the transmission and interchange of facts, ideas, feeling or course of action. (Leland Brown)
4. Communication is a social interaction through messages ( Grabner, 1967)
5. The interchange of thoughts or information to bring about mutual understanding and confidence or good human relation. (American society of Training Directors).
6. 'One mind affecting another' (Claude Shannon)
7. 'The mechanism through which human relations exist and develop' (Wilbur Schramm)
8. 'Transmission of stimuli' (Colin Cherry)
9. Communication is the sum of all the things one person does when he wants to create understanding in the mind of another. It is a bridge of meaning. It involves a systematic and continuous process of telling, listening and understanding. (Louis Allen)
10. Communication refers to the act by one or more persons, of sending and receiving messages distorted by noise, within a context, with some effect and with some opportunity for feedback (Joseph A.Devito)

The definitions given here indicate the following facts:

- A world without communication is unthinkable
- Communication is a complex process
- Communication is essential for human relationships and progress
- Human mind, body and physical conditions are vital components of communication
- A common symbol system is essential for communication

### **Importance of Communication**

Communication is important for all beings that lead community life and form relationship. For human beings communication is as essential as food, shelter and dignity. While animal kingdom uses low level symbols for communication, human beings have unique capacity to use language.

The basic foundation of human society is communication and it takes place at different levels - within oneself, between individuals, between individual and a group, between groups, between countries and so on. Similarly, we use verbal and non-verbal forms of messages for communication.

Communication is essential for development of the society. We attain cultural, social and economic prosperity by sharing out experiences. How can we share experience without better communication?

Personal enjoyment is communication based. Just think of a person kept in isolation without any chance for communication with his friends and relatives. It is really a punishment, a prison life. Communication helps us interact with our surroundings, thus create positive relationships, share love, build up friendship and depend each other to enjoy life.

Can you imagine a world without media? Not at all. The basic mission of mass media is to create ties in human society sharing news. In modern world, media have some more roles to play. Media defines our political system, form public opinion, support public demands and set agenda of our social life. In short, no social activity, be it marketing, business, education, politics, media profession..., is possible without communication.

### **Functions of Communication**

Considering the essentiality of communication, scholars enumerated the following functions of it.

- a) Education: To transfer knowledge for the progress of the society  
(Example: class room communication)
- b) Information: To find and explain some thing new (Example: News media)
- c) Cultural promotion : To help foster social values and pass them from generation to generation (Example: Festivals, parties, celebrations)
- d) Social contact: To help make enjoyable companionship (Example: Friendship, clubs, organizations etc.)
- e) Integration: To create harmonious relationships among various social groups (Example: Political parties, conferences, meetings etc.)
- f) Stimulation: To create interest and develop positive thinking /behavior(Example: Advertisements)
- g) Counseling: To alleviate anxiety and lead to better ways (Example: guidance, consolation etc.)
- h) Expression of emotions (Example: crying, smiling etc)
- i) Entertainment: To help pass time and enjoy life (Example: drama, song etc.)
- j) Control function: To get someone to behave in an appropriate way (Example: management, censorship etc)

## Elements of Communication

Let us analyse Joseph A Devito's definition that 'communication refers to the act by one or more persons, of sending and receiving messages distorted by noise, within a context, with some effect and with some opportunity for feedback' to find out the essential elements of communication.

According to his definition, communication has the following elements:

- a) Sender
- b) Message
- c) Channel
- d) Receiver
- e) Noise
- f) Feedback
- g) Context
- h) Effect

Discussion on each of these elements with examples will give us more insight into the entire process of communication.

### Sender

**Sender** is the idea generating component in communication process. In human communication, sender may be a person or persons who create or formulate the message to be sent to the receiver. Being the primary source of the message, sender is also termed as source.

In mass media, for example, news reporter is the sender or source as he/she constructs the message (news story). In a musical performance, the singer is the sender as his message is enjoyed by the audience.

Sender is a critical component in communication as his/her social background, personality status, education etc influence the quality of the message he/she creates. The message is created from the idea generated in the mind of the sender. The idea generation process is called **encoding**.

The source/sender has three functions:

- a) To decide what is to be communicated
- b) Encoding (Put the idea in such a way that the receiver understands it)
- c) Transmitting the message to the receiver

### Message

The message is any verbal or non-verbal method that produces meaning in the mind of the receiver. Simply, it is the meaning transferred from sender's mind to receiver's mind. This happens mainly in two ways: verbal and non-verbal methods.

**Verbal message** means written or oral messages. They are composed of words. Example: A newspaper report or a lecture by a teacher.



**Non-verbal messages** are those communicated through our behaviour, movements, actions, clothes, style of conversation, pitch of the sound etc.

What is fundamental in message construction is the agreement between sender and receiver in the code used for it. If the receiver cannot identify the language or meaning of the message, the communication will be defective.

### Channel

The **channel** means medium by which sender transmits the message to the receiver. Our five senses such hearing, touching, smelling, tasting, seeing are basic natural channels of human communication. Communication can be classified on the basis of five basic natural channels. They are:

**Tactile communication:** Communication by touch or taste

**Olfactory communication:** communication by smell

**Audio communication:** Communication through sound waves

**Visual communication:** Communication through visual elements or properties.

We use any technically developed medium (like television, newspaper, books etc) with the help of one or more of these five senses. Similarly, sender uses one or more channels to maximize the communication effect. For example - multi-media class room where teacher uses projector, blackboard, lecture, gestures etc. simultaneously.

### Receiver

Idea receiving end in communication process is called **receiver**. A person or thing may be at the receiving end. The receiver's role is as important as a sender's role. As in the case of a sender, receiver has also three roles to play:

- a) To receive the message
- b) To decode the message

**Decoding** is the process of extracting a message from a code and interprets it. For this, sender and receiver should have knowledge about the code (for example: language) used in communication.

- c) To respond to the message through feedback

Receivers may be audience watching movies, persons listening to music, students hearing a lecture or a computer getting e-mail from a remote server.

Communication fails or remains faulty when message is rejected or misinterpreted by the receiver.

### Feedback

Information or message that is fed back to the source is called feedback. If you get clapping for your singing, clapping is the feedback. Questions raised by students in a class room for more information is another example for feedback.

Feedback originated either from the sources' own message is called **self feedback**. Example: When you talk to somebody, you hear yourself and evaluate your tone, pitch etc.

Sometimes you may think that you could have sharpened or softened your tone or pitch or text, because of your own feedback.

Another type of feedback is that originated from the receiver. It may be in the form of questions, applauses, puzzled look etc.

Feedback may be negative or positive, immediate or delayed.

Receiver's indication to the sender that the message was not received well is called **negative feedback**. Eg. Looks of indifference, rejection or boredom may be considered as negative feedback.

Receiver's favourable responses like acceptance, applauses etc. **are positive feedback**.

Feedback at the time of the communication itself or just after it is **immediate feedback**. Eg. Applauses a singer gets during the performance.

Receiver's response relatively much after the communication is **delayed feedback**. Eg. Letters to the Editor.

## Noise

Noise or communication barrier is any thing that distorts message. Noise may originate in any of the components of communication like source, message, channel, context, receiver etc. Noise is present when there is difference between the message sent and received. Communication is not possible without noise, but its effects may be reduced through various methods such as using good grammar, clear voice, simple language, quality signal etc.

Noise is of different types depending on the nature and reasons of the distortion.

They are:

Psychological noise: Any communication error due to the psychological reasons. Eg. A fearful audience can't enjoy the musical programme.

Semantic noise : Language related problems in communication. Eg. Poor grammar, complex sentence structure, rare vocabulary etc.

Contextual noise: If communication takes place in inappropriate time or place, message is not conveyed well. Eg. Wishing compliments during a funeral function. Or An outdoor meeting at noon in a hot summer.

Channel noise : Medium related communication barrier. Eg. Poor signal affecting picture clarity of television.

## Context

Communication takes place in a context. At times it is noticeable and at other times not. In other words, time, place, culture, physical and social condition and psychology of the participants are important in determining communication effect. If we try to interpret a message out of its context, we may get an entirely different meaning which may result in communication error.

Rules and roles are two important factors related to communication context.

Rules are the norms we have to follow while communicating in different situations. For example, our communication behaviour is different when we are in class room, market or prayer hall, depending on the rules the situation demands.

Roles are the character or part each participant in communication has to play. For example, in family communication situation, father plays a leader's role. In class room, students play the receiver's role.

## Effect

Why do we communicate? It is a fundamental question. To make some effect on the receiver is the answer. Effect is consequence or result of communication. Every communication act makes some effect on the person/s. Effect may be positive or negative. Communication is said to be success when we achieve the indented effect.

Communication effects are of three types:

Cognitive effects: The consequences take place in the receiver's intelligence due to communication. Example : Knowledge acquisition

Affective effects: The consequences occurred in the emotions of the person/s due to communication.

Eg. Compassion, love etc.

Behavioral effects: The change in the receiver's behaviour or actions due to communication.

Eg. Political campaign and change in people's voting behaviour or purchasing new products inspired by the advertisements.

Using these elements, let us have a graphical representation of communication process. graphical representation of communication process is also called communication models.

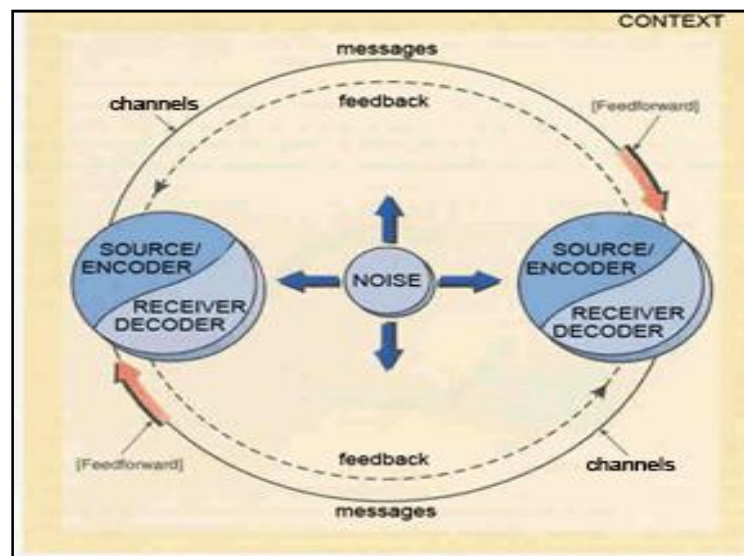

*A basic model of human communication*

While analysing this model, we should keep in mind that

- Communication is a dynamic process involving different elements. No element is static.
- Some or all of these elements make communication possible. It is not must for a communication act to have all these elements.
- Elements of communication are interrelated.

### **Scope and Purpose of Communication Models**

A model is a miniature, a highly selective visual representation of any reality. In that sense, communication model means graphical/visual representation of communication process using various elements involved. The best example is the above described graphic that visualizes various elements and processes in the communication as envisaged by Joseph A Devito.

#### **Purpose of Communication Models**

A graphic representation of any reality helps us visualize the relationships among various elements of a structure, system or process; an object, event or act. Mc Quil and Windhal say that a model is a consciously simplified description in graphic form of a piece of reality. No single model can be expected to present a holistic picture of reality. Communication models help us to visualise, analyse and discuss various complex processes and issues that would be otherwise difficult to explain

#### **Functions of models**

Organizing function: Models help us by ordering and relating systems to each other by providing with images of whole that might not otherwise perceived

Explaining function : Models help us study communication by providing simplified version which would otherwise be complex

Yet another function of communication is heuristic in nature. It means that in the study of communication, models guide researchers to the key points of the process or system

Thus communication models help

- a. to assign probabilities to formulate hypothesis in research
- b. to predict outcomes
- c. to describe the structure of a phenomenon

#### **Aristotle's Concept of Communication**

The first known scholar who wrote about communication, though not directly, is Aristotle (384-322 BC). In his famous books, 'Rhetoric', Aristotle called the study of communication as 'rhetoric' and elaborated three elements within the process. According to him, communication process composed of a speaker, a message and a listener. Person at the end of the communication process holds the key to whether or not communication takes place.

In Aristotle's point of view,

- Communication is purposive;
- It is based on the intention of affecting others;
- Its effects can be evaluated and measured in terms of effect, and also in terms of the truth;
- Rhetoric considers not only what is or was, but also what might be.

To his communicators need to develop five skills:

- Invention - ability to generate ideas;
- Disposition - ability to organize ideas;
- Style - use of appropriate language;
- Memory - ability to recall facts & ideas;
- Delivery - use of voice and gestures.

From his observations, later scholars developed a model of communication using the elements he mentioned.

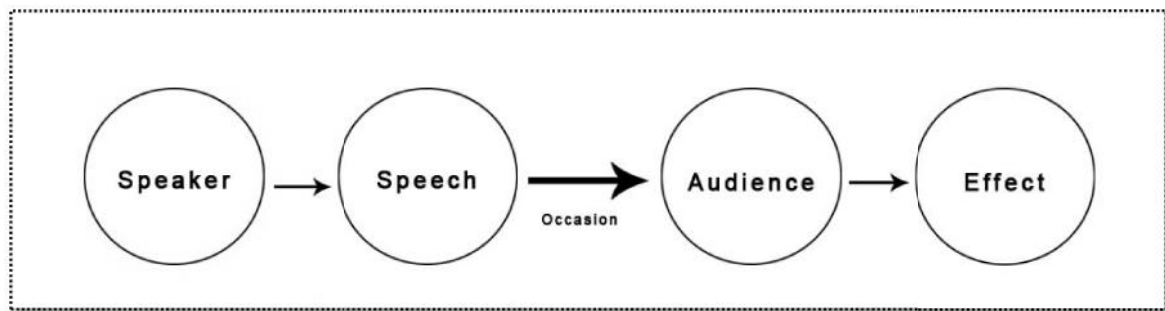

*Aristotle's Model of Communication*

The model consists of four visible elements: Speaker or receiver, speech or message, audience or receiver(s) and effect of communication. And, context or occasion of the communication covers all the elements indicating that it has influence on other four elements.

### **Lasswell Model of Communication**

Harold Dwight Lasswell (1902-1978) is the proponent of famous question formula, which is otherwise called Lasswell formula of communication. We can't call his definition of communication which is presented in an array of question as a communication model in its strict sense.

This American political scientist stated that the most convenient and comprehensive way to describe an act of communication was to answer the following questions: Who (says) What (to) Whom (in) What Channel (with) What Effect?

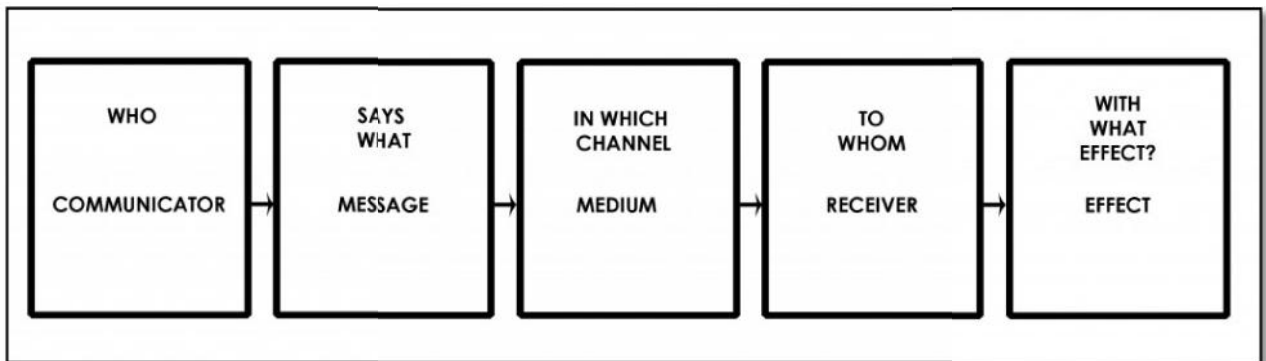

*Lasswell Model of Communication*

This model is self speaking of the process of communication which consists of five elements namely communicator (who), message (says what), medium (in which channel), receiver (to whom) effect (with what effect).

Lasswell conceived communication as a linear process which starts from communicator and ends at receiver with some effect. The major missing elements of this basic model are feedback and context of communication. However, this model is said to be highly helpful for organizing communication research as audience analysis, content analysis, control analysis, reception analysis and effect studies which are respectively represented by communicator, message, medium, receiver and effect.

### Osgood and Shramm Model

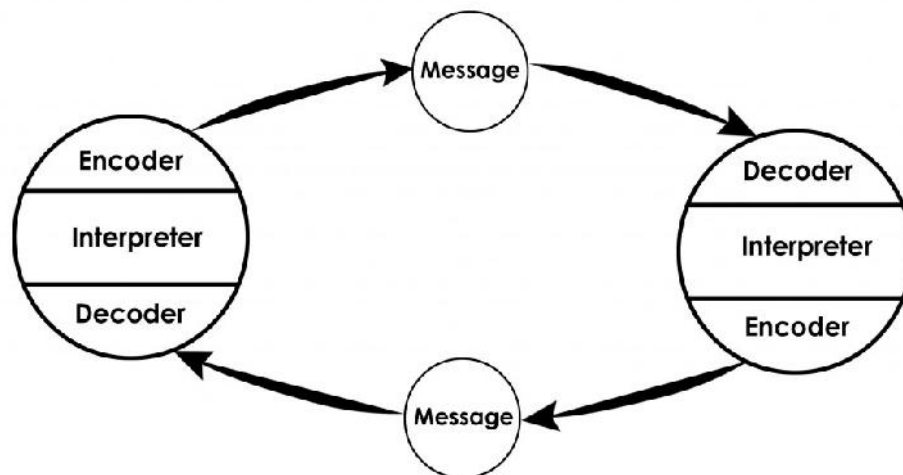

*Osgood and Schramm Model*

Osgood and Schramm envisioned communication as a circular process which has beginning and or end. Hence their model is called Circular Model. In their view, sender and receiver are interchangeable positions and though not specifically mentioned, feedback is an essential component of this model. There are three functions on each part of the communication circle. They are : encoding, decoding and interpreting. Both sender and receiver are encoders, decoders and interpreters at the same time.

Encoder - Who does encoding or sends the message

Decoder - Who receives the message

Interpreter - Person trying to understand (analyses, perceive) or interpret.

Merits of this model are:

1. Dynamic model- Shows how a situation can change
2. It shows why redundancy is an essential part
3. There is no separate sender and receiver, sender and receiver is the same person
4. Assume communication to be circular in nature
5. Feedback - central feature.

### David Berlo's Model of Communication

David Berlo's model of communication has four major parts : source (S), message (M), channel (C) and receiver (R). It is conceived as a linear model. This model is otherwise called SMCR model denoting each element

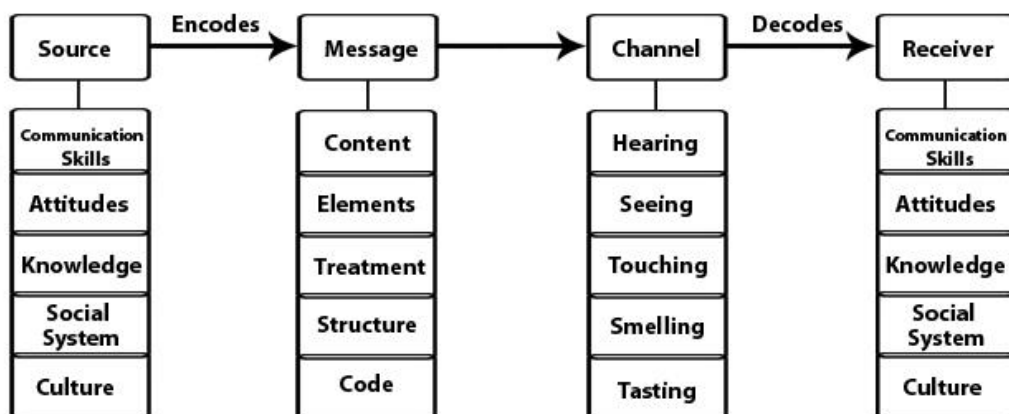

*Berlo's Communication Model*

Unlike other models SMCR model elaborates the sub sects of major components indicating the influence of external factors like culture, language, text and social system and sensory organs on communication process.

Berlo's model has the following demerits:

- a. No feedback / don't know about the effect
- b. Does not mention barriers to communication
- c. No room for noise
- d. Complex model
- e. It is a linear model of communication
- f. Needs people to be on same level for communication to occur but not true in real life
- g. Main drawback of the model is that the model omits the usage of sixth sense as a channel which is actually a gift to the human beings (thinking, understanding, analyzing etc).



## Shannon and Weaver Model of Communication

Claude Shannon, an engineer at the Bell Telephone Company, along with Weaver developed the most influential of all early communication models. Their goal was to formulate a theory to guide the efforts of engineers to find out the most efficient way of transmitting electrical signals from one location to another.

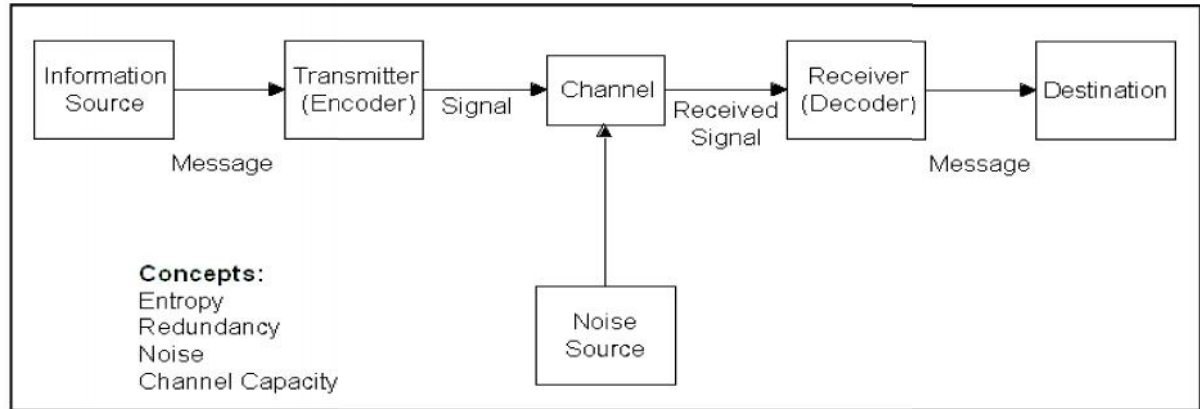

*Shannon and Weaver Model of Communication*

As the prime concern of the developers of this model was to quantitatively maximize the signals transmitted, this model is also called Mathematical Model of Communication. The model is based on technical communication settings where information source transmits the messages after converting it to signals. These signals are captured using receivers and decoded. Communication through mechanical devices like telephone or television is a best example for this model.

## Dance's Helical Model of Communication

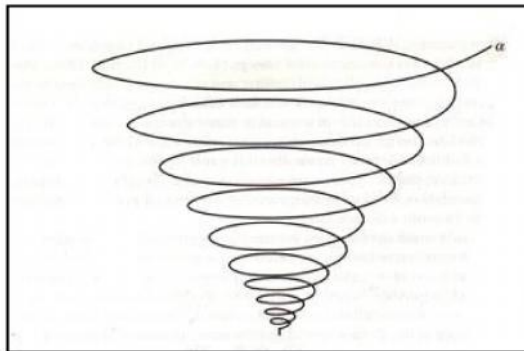

*Dance Model of Communication*

The Helical Model of communication was proposed by Frank Dance in 1967. A helix is nothing but a smooth curve just like a spring which if goes upwards also comes downwards. Dance thought of communication process similar to helix. Dance's model emphasized the complexity of communication. He was interested in the evolutionary nature of the process of communication. According to him, once communication started, it develops gradually according to time. This model disagrees with the traditional concepts of linearity and circularity in communication and stresses the helical spiral nature of the process. According to Dance, earlier communication helps widen the nature and context of further communication. To him, communication has a very simple beginning and it widens as time and context permit.



## MODULE II

### DEFINING MASS COMMUNICATION

#### Objectives

This unit will introduce

- Components of mass communication
- Channels of mass communication
- The process of mass communication
- Nature of mass communication
- Functions and dysfunctions of mass communication
- Types of mass media

#### Introduction

We learnt to define communication, identify its elements and categorize the process based on the number of persons involved in it. Of the above mentioned types of communication, our focus is on mass communication. In this unit, we will learn the various aspects of mass communication, which is the thrust area of this programme.

#### Components of Mass Communication

For better understanding of the nature of mass communication, we should analyze its two basic components : the mass and the communication media.

#### The Mass

The concept “*mass*” in mass communication is defined as a large, heterogeneous, assorted, anonymous audience.

‘*Large*’ means we can’t exactly count the number of the members of audience. It is relatively large but it doesn’t mean that the audience includes all people.

‘*Heterogeneous*’ means the audience of mass media includes all types of people – the rich, the poor, farmers, bureaucrats, politicians and so on.

‘*Assorted*’ means the audience of mass media is not necessarily limited to a particular geographical sector. They may be scattered everywhere. For example, a newspaper may have a reader in every nook and corner of the world.

‘*Anonymous*’ means we can’t specifically identify a reader of a newspaper of newspaper with his certain characteristics. Today he may be reader of a particular newspaper. Tomorrow, he may change his media habit. Anybody at any time may be a member of mass media audience.

The channels of communication that produce and distribute news, entertainment content, visuals and other cultural products to a large number of people. Mass media can be classified in to three major groups on the basis of their physical nature.

They are:

- Print Media like newspaper, magazines and periodicals, books etc.
- Electronic like radio, cinema, television, video and audio records
- Digital Media like CD RoMs, DVDs and the Internet facilities.

### Mass Communication Process

How does mass communication work can be well explained in linear model of mass communication?. According to this traditional concept, mass communication is a component system made up of senders ( the authors, reporters, producers or agencies) who transmit messages ( the book content, the news reports, texts, visuals, images, sounds or advertisements) through mass media channels ( books, newspapers, films, magazines, radio, television or the Internet) to a large group of receivers ( readers, viewers, citizens or consumers) after the filtering of gatekeepers ( editors, producers or media managers) with some chance for feedback ( letters to editors, phone calls to news reporters, web-site postings or as audience members of talk shows or television discussions). The effect of this process may formation of public opinion, acceptance of a particular cultural value, setting the agenda for the society and the like.

A simple linear model of mass communication situation can be represented with the diagram given below.

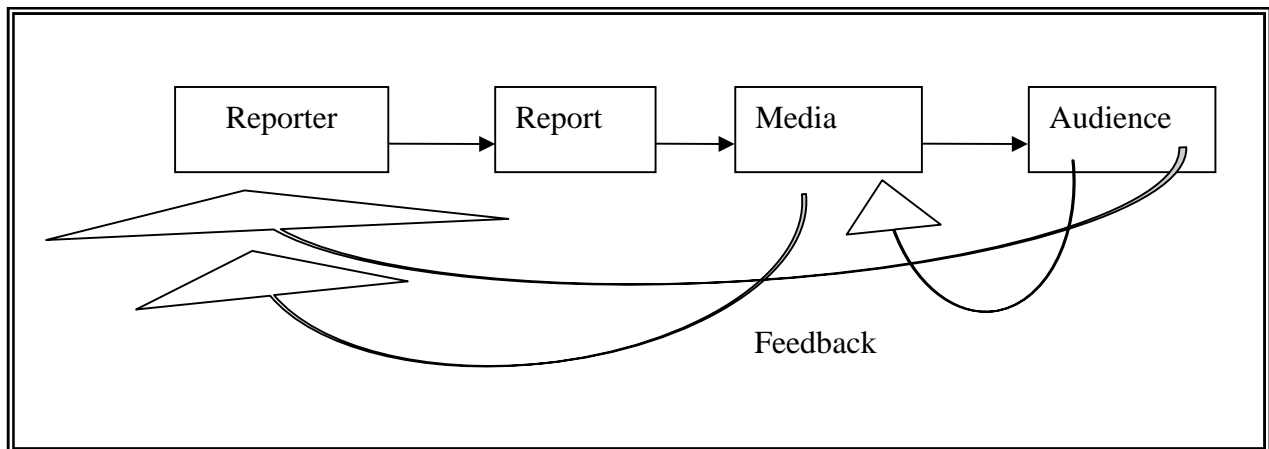

### Nature of Mass Communication

From the above model of mass communication, it is easy to identify the following features of mass communication.

1. Mass communication experience is public one. It means that anybody can be a part of this communication process at any time without much effort or permission.
2. It is a mediated communication act. Nature of the media involved in the process defines the mediation in mass communication. For example, television can transmit a news instantly as it is a fast medium, newspaper takes to bring the same news report to the public because of its limitations. This is how nature of the media defines the mediation process in mass communication.

3. Mass communication is filtered communication. This filtering processing is called gatekeeping. For example, a news report in a newspaper or on a television channel filtered or controlled at different level by reporter, sub editor, news editor, editor.
4. It is the most complicated form of communication as it involves complex technology like satellites digital networks, management structure, marketing chain etc.
5. Mass communication can alter the way the society thinks about events and attitudes.
6. Mass communication experience is transient. It means that once you used a message ( for example, a news report or a film) you may not use it again. The message is meant to be used once and it is gone. Who will read yesterday's newspaper?
7. Mass communication is most often remains as one-way communication. As receivers, how many of us write letters to editor (sender)? A very few. But, in interpersonal communication, senders and receivers are in active conversation sending feedback to each other.
8. Unlike other communicators, mass communicators can't see their audience. Karan Tapar or Pranoy Roy, the leading television personalities in India know that their programmes are watched by millions of Indians. But, they can't see how people respond or react while watching their presentations. That's why they can't change the style of presentation or mode of communication instantly as we do in interpersonal or group communication.

## **Mass Media**

Mass media influence our daily life more than any other cultural institution. They are our main sources of news and entertainment. They define our purchase decision, voting behavior, academic achievement and so on. Because of this all-encompassing impact of mass media, politicians, businessmen and government agencies depend on media to influence people. During election time, we witness politicians spending millions of rupees for political campaign through mass media. Business firms across the world spend billions of dollars to market their products with the help of mass media advertisements. We are informed of the policies of our governments through newspapers and electronic media. Likewise, we people need mass media to express our needs, complaints and wishes to the authorities. In short, role of mass media in our society is omnipresent.

## **Defining Mass Media**

According to Wilbur Schramm 'a mass medium is essentially a working group organized around some device for circulating the same message, at about same time, to a large number of people'.

From this definition, let us know that there is a well organized system behind each mass medium. For example, a newspaper is produced everyday with the collective efforts of a lot of people using various information sources ranging from local reporters to international news agencies. Same is the case of distribution of the newspaper also. Everybody from circulation manager to local newspaper boy is actively engaged in smooth circulation of each copy of a newspaper. Moreover, every county has its own policy, laws, and telecommunication systems to facilitate mass media. In this sense, the production of a mass medium is the result of a well organized system.

And, the messages are disseminated to a large number of people ie. *mass*. They are called the audience. No media can sustain without a sufficient audience. We learned the characteristics of mass audience in the earlier unit.

The definition again talks about devices of circulating messages. These devices are technological means through which messages are communicated to the audience. Devices include printed documents, television, radio, DVD, cassettes, the internet etc.

### **Types of Mass Communication**

Mass media can be categorized according to physical form, technology involved, nature of the communication process etc. Given below are the major categories of mass media.

#### **Print Media**

Johannes Gutenberg's invention of the moveable metallic type in the fifteenth century paved the way for proliferation of the print media. The printing press using moveable types introduced the method for mass production of texts. Before the invention of the printing press, books were expensive materials affordable only for the aristocrats and royal families. Printing reduced the cost of books and made them available to the common men also. Rapid duplication of multiple copies of handy texts led to the innovation of modern newspapers.

Print Media include

- Newspapers
- Magazines
- books
- other textual documents

#### **Electronic Media**

The history of electronic mass media starts with the invention of radio by Marconi. The first radio station was set up in Pittsburg, New York and Chicago in the 1920s. Following the USA, European countries also started radio stations for broadcasting news and entertainment content. The colonial powers like Britain and France set radio stations in Asian and African countries in the early years of 20<sup>th</sup> century. The next step in electronic communication media history was the invention of cinema. Following cinema, television broadcasting was initiated in the US on experimental basis during 1920s. But, the dramatic impact of television as a mass medium began in 1950s. Parallel to these, recording industry was also boomed in the western countries. In short, the term electronic media mainly include:

- Radio
- Movies
- Television
- Audio and Video records

## **New Media**

Online and digital means of producing, transmitting and receiving messages are called new media. The term encompasses computer mediated communication technology. It implies the use of desktop and portable computers as well as wireless and handheld devices. Every company in the computer industry is involved with new media in some manner. The forms of communicating in the digital world include

- CD-RoMs
- DVDs
- Internet facilities like World Wide Web, bulleting boarding, email etc.

## **Functions of Mass Media**

As mentioned earlier, mass media have pervasive effects on our personal and social life. The role and scope of mass media in our society are in the following areas:

- Information
- Education
- Entertainment
- Persuasion

### **Information function**

Mass media carry a lot of information which are essential for our day to day life. We know exam results, weather forecasts, current affairs, traffic regulations, last dates, precautions, government policies etc. from mass media. The core of media's information function is performed by the media content called news. The place or time dedicated for news in a mass media is called news hole. News is the most consumed item of any media. News can be defined as reports on things that people want or need to know. Information should be accurate, objective and complete. Biased or incomplete reports will keep the audience away from the media.

Advertising is also mass media's information function. We get much useful information from classified advertisements.

### **Education function**

Information is different from education. Education is systematically organized information with predefined objectives. The primary source of education in our society is schools or colleges. Media also perform the functions that educational institutions do. Media are life-long educators for the society. They give us comprehensive knowledge of selected topics. Non-news content or news-based content like editorials, articles, columns in newspapers provide us with complete idea of a subject. Health Magazines, IT magazines are also examples for education through media. Recently, mass media in Kerala directly participate in our educational system by publishing educational supplements for school-goers . Padippura of Malayala Manorams, Kutty.com of Mathrubhumi, Velicham of Madhyamam, Kilivatil of Deshabhimani are examples. Moreover, we have a number television channels dedicated for mass education. Victors of IT @ School Project of Kerala Government, Vyas Channelr of Consortium of Educational Communication under University Grants Commission, Gyandarsan of Doordarshan are some of such efforts.

### **Entertainment function**

Irrespective of their type, mass media are wonderful entertainers. All media have entertainment content. Newspapers publish cartoons, comics, puzzles, special weekend supplements for amusing people. Lion share of magazine content such as short stories, novels, satires and cartoons are for entertainment. Movies are another big stock for entertainment. Audio-Visual media such as television and radio are also primarily concentrate on entertainment function through their programmes based on sports, film, and fashion shows etc.

### **Persuasion**

Persuasion means influencing attitudes or opinions. Mass media have many ways to persuade people. Most people form their opinion from information they get from mass media. Media have direct and indirect methods for persuasion. For public opinion formation, mass media use editorials, news analysis and commentaries. In such cases, the purpose is clear and direct. The most obvious method of persuasion is advertising. Advertisements are direct methods to influence purchasing behaviour of the public. Some media report events hiding their vested interests in news. Such biased, subjective reports are for persuading people to form favourable attitudes towards them or their interests. Opinionated news is an undirected method of persuasion. It's against the ethics of responsible journalism. News and opinion should be given separately.

According to western media scholars like Harold Laswell, mass media, be print or electronic, have the following functions:

### **Surveillance of the environment**

Mass media observe the society and its activities and report them to make people aware of their socio-cultural environment. In other words, we as social animals are always under the close observations of mass media. Media are our watchdogs. It always watches who do good things and who do bad things, and report them to encourage or correct our deeds. Reports about corruptions are good example. Considering this watchdog function of mass media, we call the media as the *Fourth Estate* of our democratic political system. The other estates are Legislative, Judiciary and Executive.

### **Transmission of heritage**

Mass media are the bridge between our past and present. They report day to day affairs which will become history of tomorrow. The best records of modern history are newspapers of yesteryears. We get our cultural tradition from history and we follow the best of them. In keeping our culture flowing, media play a vital role. It advises us which part of our culture is good and to be followed and which is bad and not to be followed.

### **Interpretation of information**

Mass media provide us with information from every nook and corner of the world. They do not just report facts and figures of the events, rather they interpret events to make us aware of what happens, and why, where, when and how it happens. Media interpretation may be biased or not. But, it helps develop our views towards an event or object or personality. Every media report is an analysis and one version of the fact. There may be another versions and analysis.



### **Prescription for conduct**

How should we behave in a society? What should be our approach towards something important to the society? What is good for social life? As a member of a larger social system, we face these questions every now and then. In most cases, mass media provide us answers. During the election time, we are confused of electing a candidate. But, news coverage of political policies and leaders of various parties give us an insight that helps us take decisions. This is how media prescribe our political conduct. So do the advertising. Which product or service is better? Which is suitable to our budget? We depend on advertisements before taking purchase decisions.

### **Catalyst for Development**

In a country like India, media's role in national development is highly important. Media's contributions to national development are mainly in two ways : As advocates for development and as carriers of development messages. Mass media find out problems faced by people in different walks of their life and make the administrators aware of them. Most often, media report such events and further campaign to get the grievances redressed. On the other hand, media make people aware of their rights, government subsidies, development policies and the merits and demerits of adopting or practicing them for better life. Government controlled media perform these duties better than the private media do. This development orient function of media is termed as Development Communication. Development Communication has been recognized as a special area in communication study and research.

### **Nature of Mass Communication**

From the above model of mass communication, it is easy to identify the following features of mass communication.

1. Mass communication experience is public one. It means that anybody can be a part of this communication process at any time without much effort or permission.
2. It is a mediated communication act. Nature of the media involved in the process defines the mediation in mass communication. For example, television can transmit a news instantly as it is a fast medium, newspaper takes to bring the same news report to the public because of its limitations. This is how nature of the media defines the mediation process in mass communication.
3. Mass communication is filtered communication. This filtering processing is called gatekeeping. For example, a news report in a newspaper or on a television channel filtered or controlled at different level by reporter, sub editor, news editor, editor.
4. It is the most complicated form of communication as it involves complex technology like satellites digital networks, management structure, marketing chain etc.
5. Mass communication can alter the way the society thinks about events and attitudes.
6. Mass communication experience is transient. It means that once you used a message ( for example, a news report or a film) you may not use it again. The message is meant to be used once and it is gone. Who will read yesterday's newspaper?
7. Mass communication is most often remains as one-way communication. As receivers, how many of us write letters to editor (sender)? A very few. But, in interpersonal communication, senders and receivers are in active conversation sending feedback to each other.
8. Unlike other communicators, mass communicators can't see their audience. Karan Tapar or Pranoy Roy, the leading television personalities in India know that their programmes are watched by millions of Indians. But, they can't see how people respond or react while watching their presentations. That's why they can't change the style of presentation or mode of communication instantly as we do in interpersonal or group communication.

## MODULE III

### PRINT MEDIA

#### Objectives

This Unit will help you

- Identify the features of the print media
- Learn different types of print media in detail
- Learn about various print media: newspaper, magazines and periodicals and books.

#### Introduction

In 1457, Johannes Gutenberg invented movable metal types. This paved the way for mass production of printed materials. Resultantly, presses and publications spread rapidly first across Europe, then in other continents. Mass production of printed documents led to democratization of knowledge. In other words, it made knowledge and education accessible to common people. It was exactly a revolution because till then knowledge was considered the property of the elite.

As we learned in the last unit, the primary print media are three: books, magazines and newspapers.

The print media are different in their binding, regularity, content and timeliness, though the means and methods for production are similar to certain extent.

Features	Types of Print Media		
	Books	Magazines	Newspapers
<i>Binding</i>	Stitched /Glued	Stapled	Unbound
<i>Regularity</i>	Single Issue	At least quarterly	At least weekly
<i>Content</i>	Single Topic	Diverse Topic	Diverse Topic
<i>Timeliness</i>	Generally, not timely	May be timely or untimely	Timeliness is important

These are not rigid distinctions. However, they are helpful to understand the features of each type.

#### Newspapers

Newspapers are periodically published documents that carry current information about the society. Earlier newspapers were not daily publications as we see now. They were published weekly or bi-weekly. This was due to the absence of adequate technology and newsgathering system. By the early 19<sup>th</sup> century, power press was invented. This led to fast printing. Invention of telegraph and teleprinter also helped us gather news from remote places. This all facilitated the introduction of daily newspapers.



The first newspaper was *Publick Occurrences* published by Ben Harris in 1690. The first newspaper published in India was the *Bengal Gazette* by James Augustus Hicky in 1780. It is also called *Hicky's Gazette*.

Newspapers are primary mass medium from which people receive news. The research results show that newspapers reach more people than any other medium do. And, by every measure, newspaper industry overpower all other media, be it in advertising revenue and in the size of audience.

Unlike other mass media, newspapers influence people in a many significant ways. A newspaper article or news is valued more than television or radio programmes. And, newspaper content is considered more credible and accurate. Capability to be used for future reference make newspapers people's favorable medium, especially for the middle and working class for they can use it after their working hours.. Diversity of content is another feature this medium. It can carry a rich mix of news, features, articles, columns, cartoons, graphics, editorial etc. And, readers can select what they want from the entire content. Some people prefer sports page and they read it first while others look for political news and some other for stock market. Selectivity and content diversity make newspapers a real mass medium. This is not possible in the case of radio and television.

In any society, the traditional newspapers are part of their culture and social system. They talk about their newspapers affectionately because they give them information, education, entertainment, more over ways for socialization and legitimization of new values. In democratic society, the Press is the Fourth Estate. At primary level, the Press means newspapers.

Of the print media, newspapers are the most read one. It is assumed that 3 out of every 4 literates read newspapers. In United States of America, daily newspapers reach 185 million people a day. For advertisers, newspaper is a medium of choice since it attract active readers (active audience) compared to any other media.

Even then newspapers are facing many challenges from electronic media and new media.

Newspapers are printed products created on a regular (weekly or daily) basis and published in multiple copies, containing mainly updated information about happenings in the society. Regular newspapers were not in circulation till 17<sup>th</sup> century because of the absence of adequate printing or duplication technology.

### **Role of Newspapers**

In their early years, newspapers were centre of debate and they were run by scholars, political leaders, reformers and revolutionaries. The main mission of the Press in its infant stage was to argue with government for better life conditions and freedom of the people. Because of their capability to raise public opinion and alternative thinking, the Press at that time is called by media historians as adversarial press. During this period, governments imposed stringent licensing systems and taxes on newspapers. In spite of these measures, English newspapers continued their battle against colonial policies of the Britain. The public anger created by the Press culminated in the American Revolutionary War. The newspapers in other countries may also have same kind of stories to tell. The early newspapers, both in English and in local

languages in India also formed public opinion against the British policies and at last resulted in the withdrawal of English forces from Indian soil.

Advances in printing technology encouraged newspapers to adopt new modes of production and distribution which led to mass circulation of the medium. **Circulation** means the number of newspapers people paid for or received free in one publishing cycle. The steam powered cylinder press invented by Hoe and Company and development of low-cost newsprint were the innovations in printing sector. These made it possible to print thousands of copies in a short time and sell them at a price low enough that even working people could afford. It was then newspapers became the real mass medium. During 1800s, with their popularity newspapers were sold on the street at a low price. So they are called **penny papers**. Newspaper circulation increased into tens of thousands due to the popularity they gained over decades and more and more innovations were introduced in printing sector. Rotary press with revolving types and offset press are some of them.

### Characteristics of Newspapers

Primarily newspapers are print media even though digital age offers online newspapers and e-newspapers. That is why it has all the features that any print medium has. Major features of mass media are given below:

**Predominance of news-oriented content:** There are three types of content in newspapers: news, views and advertisements. Of these news overshadows the others because newspapers are primarily meant for the dissemination of news.

**Regular periodicity:** Newspapers may be published daily or weekly. Periodicity may vary but, regularity should be kept. Every newspaper keeps a particular regularity in publication.

**Future reference facility:** Being a print medium, newspapers can be kept for future use. This archiving ability makes newspapers one of the main sources of historical research.

**Choice of the time of use:** Unlike television and radio, we can read newspapers at any time. Some read in the morning while others in the evening after work. This facility increases the popularity of newspapers.

**The Literates' medium:** Unlike television and radio, newspaper demands literacy from the part of the audience.

**Low cost:** Compared to other media, newspaper is a cost effective medium. Anybody can afford a newspaper as it needs no hidden charges or other accessories. Electronic media requires power supply and the new media need digital technology.

**Multiple Users:** Many readers can read a copy of the newspaper simultaneously or separately.

**Textual Medium:** Text is the soul of newspapers, though they carry images and graphics.

### Types of Newspapers

Newspapers can be categorized into various types based on their page size/format, content type, periodicity, time of publication, area of circulation and type of the users.

### By Page Size/Page Format

By size, newspapers can be divided into three: Calendar, Tabloid and Berliner

- **Broadsheet** is the largest of the various **newspaper** formats and is characterized by long vertical pages (typically 22 inches / 559 millimetres or more). The term derives from types of **popular prints** usually just of a single sheet, sold on the streets and containing various types of material, from **ballads** to political satire. The first broadsheet newspaper was published in 1618. Most of the Malayalam newspapers are in broadsheet format.

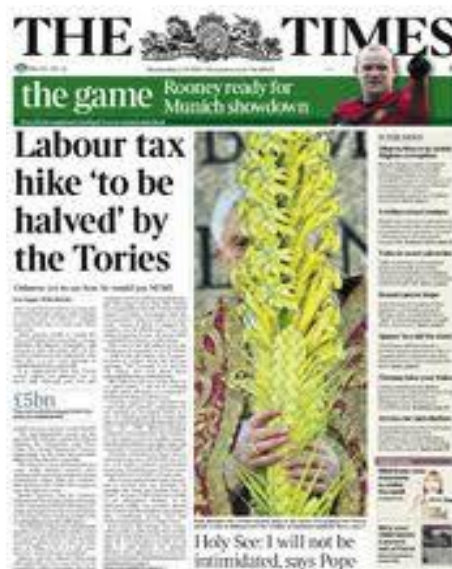

*Broadsheet newspaper*

- **Tabloid** is a smaller newspaper format per spread mostly used for a weekly or semi-weekly alternative newspaper that focuses on local-interest stories and entertainment. The tabloid newspaper format is particularly popular in the **United Kingdom** where its page dimensions are roughly 430 × 280 mm (16.9 in × 11.0 in). Tehelka, well known Indian news weekly is in tabloid format.



*Tabloid newspaper*

- **Berliner** is a [newspaper](#) format with pages normally measuring about 470 × 315 mm (18.5 × 12.4 in). The Berliner format is slightly taller and marginally wider than the [tabloid](#) format; and is both narrower and shorter than the [broadsheet](#) format. The Berliner format is used by many European newspapers, including dailies such as [Le Monde](#) in France, and [The Guardian](#) in the [United Kingdom](#).



*Berliner format*

### **By time of publication**

- Morning Dailies
- Evening Dailies

### **By Content**

By content type, newspapers are mainly classified as general newspapers, political newspapers, and financial/business newspapers. Some other categories are also possible, but not in currency.

### By Periodicity

Dailies and weeklies are two type of newspapers based on the periodicity. Dailies are newspapers that are published at least five times a week and weeklies are those published once a week.

In the West, Sunday newspapers are a common scene. But in India, newspapers publish literary / entertainment/ cultural supplements for leisure reading.

### By Circulation Area

- **National Dailies:** Their primary area of circulation is across the nation. Wall Street Journal, USA Today are national dailies of the USA. Guardian, Sun and Independent are British dailies. The Hindu, Times of India and Hindustan Times are national dailies in India.
- **Hometown newspapers:** Town-centric newspapers focusing issues on that particular city is called hometown newspapers. *Midday* of Mumbai is an example.
- **Metropolitan dailies:** Dailies concentrate on the affairs of a metro city. Examples: *Metro Vartha* of Malayala Manorama.

### By Audience

- **Community Newspapers:** Newspapers published on and by a community. Eg. Newsday based in New York. Deepika in Malayalam.
- **Religious Newspapers:** Newspapers published by religious organizations, focusing on religious news with a mission of propagation. Eg. Punybhoomi
- **Immigrant and Ethnic Newspaper:** Newspapers published by ethnic groups living in alien lands as expatriates like Indians in the Gulf countries. Benjamin Franklin's *Philadelphische Zeitung* in 1732 is the first of its kind. *Gulf Madhyamam* published from the Middle East is first full-fledged ethnic media in Malayalam.

### By Language

- English
- Vernacular
- Braille: Newspapers published for the blind.

### Structure of a Newspaper Organization

In general newspapers have six main departments under the direct supervision of the publisher, who manages the company's entire operations. The departments are:

- **Business Section** which includes Purchase Section, Accounting Section, Payroll Section, Human Resources Section, Planning and Development Section.
- **Editorial Section:** Editorial Desk, Field, Library and Resources Section and IT Section.
- **Production Section** : Design Section, Composing Section, Plate Making Section and Printing and Packing Section
- **Marketing Section:** Market Research Section, Promotion Section and Public Relations Section.
- **Advertising Section:** Accounts Section, Sales Section and Customer Service Section.
- **Circulation Section:** It manages the prompt delivery of the newspaper and circulation promotion methods.

## **Newspaper Production**

In discussing the production of newspaper, we shall focus on two areas: content creation and printing.

### **Content Creation**

The process of content creation of a newspaper depends on its periodicity (dailies or weeklies) and nature of circulation.

In general, publisher of the newspaper is in charge of all of a newspaper's operations, including financial matters such as getting advertisements, circulation, legal matters, human resource management, accounts etc.), production issues (procurement of production materials like newsprints, machinery etc.) and editorial issues (general policy regarding the perspectives and style of presentation of the non-advertising matters).

The publisher sets the advertising-editorial ratio subject to the rules and regulations framed by the governments and controlling agencies. Ad-editorial ratio helps us define the balance between the amount of space separately available for advertisements and editorial matters. Typical ratio between editorial/news and advertisements is 60:40 in most countries. The space allotted for news/editorial content is called news hole and the space available for advertisements is called pay hole.

Editor is the person responsible to manage all operations to fill the news hole while advertising manager under the guidance of the publisher will take care of the pay hole. There will be an array of professionals like Managing Editor, Assistant Editor, Resident Editor, News Editor, Chief Sub Editor, Sub Editor and reporters in the field to assist the Editor in his operations.

The editorial department has two distinct teams working in tandem:

- News gatherers (reporters)
- News processors (editors)

News gatherers are field staff while news processors as the desk staff.



Reporters gather news independently or under the guidance of the desk. They report news according to the content types required for the newspapers. In a typical urban newspaper, the sections based on content types might be entertainment, finance, sports, fashion television/radio, politics, culture and foreign news.

### **Production Process**

Once the news is identified, it is reported by the field staff and edited by those in the desk. Next starts the production stage. The first step in this phase is newspaper design. In some newspaper firms, sub editors themselves design pages; in others layout artists do the job. With the Desk Top Publishing (DTP), it has been easy for any computer literate to design newspaper pages. QuarkExpress and Adobe InDesign are the commonly used software for page design in Indian newspapers. Pages are set according to the dummy, a skeleton of the newspaper page, given by the advertising department after marking the space for advertisements of the day. Designer/Sub Editor arranges news stories and news photos on the pages according to their importance. To make the pages visually attractive, pages are arranged keeping

- **Symmetry** : Visual balance of the text and graphics
- **Colour balance** : Visual balance of the various color used.
- **Judicious use of white space** : To provide enough white space to avoid messy design
- **Readability criteria** : To make the page functionally readable
- **Legibility** : Clarity and visibility of the text and graphics
- **Consistency** : Standardization of the design for newspaper branding
- **House style**: Standards devised by each newspaper organization should be followed in design.

Now, the page is ready. It is handed over to senior editors like chief sub editor, news editor, assistant editor or any such supervising staff for scrutiny and approval. After the approval, the pages will go to plate making section. Earlier the plates were made after filming the pages. But, advances in technology help skip this step. Now, pages can be directly transferred to plates (Plates are aluminum sheets on which images of the pages are printed using special chemicals). These plates are mounted on to printing machines for printing. Printed newspapers are packed for transportation to the newspaper agents.

In a newspaper organization, every task has a time limit. Otherwise, we will not get newspapers early morning everyday. The time limit for completing an assignment is called *deadline*.

Very good internal communication is essential for better function of a newspaper organization. Reporters should inform what is up there in the field. Editors should inform each other about the stories allotted to each page. Designer should consult with the sub editor about arranging news on a page and with the printer about the technicalities of printing. Advertising department should give advertisement details on time and marketing section should inform the editorial section about the market needs. In short, everybody should go hand in hand for successful functioning of a newspaper organization.

## Recent Trends

Newspaper industry adopted technological advances over the years, ranging from moveable metallic types to the latest version 'PoD machines- (Print on Demand machine prints only the required number of copies and can print earlier copies in memory as and when required). The adoption of innovation doesn't confine to printing technology only; it reflects in newsgathering, editing, designing, printing, distribution and audience research.

## Online newspapers

Online newspapers are newspaper exist on World Wide Web. It is electronic version of the newspaper with all the characteristics of new media. Online newspapers are interactive and have multimedia content. They are accessible worldwide and very cost effective to publish and circulate. Typically, online newspapers have two versions: web newspaper and e-papers. E-papers are electronic version of a day's real newspaper mostly in Portable Document Format (PDF) available on the Web, while online newspaper or web newspapers are websites fully dedicated to news and other newspaper contents.



*e-paper*





Online newspaper

## Magazines and Periodicals

Unlike newspapers, magazines are periodical publications carrying non-news items. Andrew Bradford's *American Magazine* and Benjamin Franklin's *General Magazine* are considered as the first magazines. They were published in 1740s. Earlier magazines were as expensive as books. So they were affordable only to the wealthy people. Those days purchasing magazines was a status symbol. Invention of power press led to the exponential growth of magazines across the world. Most of the early magazines were started by newspaper organizations. Magazines are considered as mass medium that spread culture and nationalism.

Magazine is originally a French word which means storehouse. In journalistic terms, magazine is a collection of materials like stories, ads, poems, and other items that editors believe will interest audiences. The *Spectator* published by Joseph Addison of England in 1711 is considered to be the first full-fledged magazine in English.

Regular publication of magazines started in the United Kingdom in the eighteenth century as a result of enhanced freedom permitted by Parliament, for public discussion and arguments about

government. The earlier magazines focused on political and literary affairs. Famous writers of the day contributed to the magazines.

Because most people illiterates and magazines were costlier, magazine reading remained an elitist affair during the initial period. After England, the culture of magazine publishing and reading spread to British colonies world over. America and India were colonies where magazines were published even in the second half of 18<sup>th</sup> century. Benjamin Franklin started magazine publication in America. In India, Christian missionaries concentrated in Calcutta and Madras launched magazines aiming at religious propagation. Earlier magazines can not be considered as mass media since they served only a small section of the society.

### **Development of Magazines**

Rise in education, innovation of cost effective production, advances printing technology, new techniques in photography, transportation facilities, emergence of new writers, growth of reading culture, political freedom to discuss social issues and inclusion of diverse content and huge population growth, rise in advertisement revenue prompted mass production and distribution of magazines, first in Europe and America, then in eastern countries like India in the middle of 19<sup>th</sup> century.

After their incarnation as a mass medium, magazines started to attract special segments of the audience like women, children, professionals etc. The first trend was the rise of women magazines. The most important milestone was the publication of *Godey's Lady's Book* launched by Louis A Godey in 1830 in the USA. It had more 150,000 readers in 1850.

Industrial growth after industrial revolution and market boom led to an influx of advertisements to mass media. Magazines benefited from this opportunity. Frank Munsey, an American magazine owner showed advertising could pay most of production costs of a magazine. His low pricing attracted millions. He used hose large numbers to attract more advertisers. This is how magazine industry expanded as lucrative business in media sector. Sensational news, celebrity lives, muckraking, fictions like novels, short stories etc were the trends in magazines in the early 20<sup>th</sup> century.

In the later part of the 20<sup>th</sup> century, wide reach of television posed challenges to magazines as television programming imitated magazines in their content and presentation targeting magazine audiences.

### **Characteristics of Magazines**

- What makes magazines different from books and newspapers? Magazines are not published daily like newspapers. Periodicity of magazines are longer than that of normal newspapers. In general, they are published weekly, biweekly or monthly.
- Unlike loose sheets of newspapers, magazines are produced as bound volumes.
- Most of the magazines are meant for light reading and mainly for entertainment, rather than serious reading for information gathering as in the case of books and newspapers.
- Magazines contain diverse content ranging from poems to comics and cartoons to photo feature.

- Magazines most often than not target special, segmented audience while newspapers are for general readers.
- Magazines generally focus on special areas like culture, politics, current affairs, health, wealth, women's and children's life.
- Magazines printed in high quality papers as they are to be used for a longer period. Newspapers are printed using cheap newsprints as they are meant for one-day use.
- Normally, magazines do not have different editions as in the case of newspapers. They have only one print cycle, except for some international news and financial magazines like NewsWeek, Time, Forbes, and Fortune which publish various regional editions for Asia, Africa.
- Magazines provide room for in-depth analysis and criticism as the publishers get more time for preparation.
- Magazines are easier to preserve than newspapers

### **Role and Scope of Magazines**

Like newspapers, magazines also play vital role in defining modern society. Role and scope of magazines are to judged in terms of their content and focus, not in a generalized way.

General interest magazines and cultural and literary magazines form a social mindset that shapes our cultural identity and consciousness. In a democratic society political and cultural magazines trigger heated discussions on vital issues that touch the lives of the marginalized and the downtrodden.

On the other hand, consumer magazines prompt the society to purchase more, consume more and perish. Same is the case fashion magazines also. They create media hype about ballooned celebrity lives and misguide the audience. They only help the big business of fashion world and related cultural and entertainment industry.

Women magazines' general objective is women empowerment. But, this basic task is not performed in most cases as magazines are succumbed to advertising pressure. For example, women magazines publish advertisements depicting 'ideal' body images of women considering them as visual treat for the male audience.

### **Types of Magazines**

Magazines are of different types. Five major categories are: .

- **General Interest Magazines:** Magazines covering wide variety of topics aimed at a broad audience. They occasionally offer investigative stories and burning social issues. Eamples:. The Week, Outlook, India Today, Readers' Digest, National Geographic.
- **Business Magazines:** Also called trade magazines. They focus on topics related to a particular occupation, profession, or industry.
- **Consumer Magazines:** Consumer magazines also aim at genera public in their private and non-business lives. They are called consumer magazines as their readers prompted to consume products and services advertised in them. In modern age, most of the women's' magazines are ended up as consumer magazines. Health ,tourism and IT magazines are not exceptions.

- **Literary Reviews:** Those magazines which publish literary-oriented content including fiction and non-fiction like literary and cultural studies. Time Literary Survey and Bhashaposhini are examples.
- **Academic Reviews:** These are publications of serious nature focusing on academic research articles and available mainly through subscription or mail order. Eg. Economic and Political Weekly, Communication Research, Journal of Communication etc.
- **News Magazines:** News magazines stress the news based content and analysis. Time, News Week, Tehelka etc.
- **Comic Books:** Periodicals that tell stories through pictures as well as words and meant for purely entertainment and contain comic pictures and picture stories, puzzles and the like. Their focused audience is children. Examples: Amar Chitra Katha, Fantom, Green Lantern.

## Books

Books are bound pages of written or printed messages of considerable length, mostly on one topic. Being meant for circulation, they are produced using durable materials and in a portable form. The *Papyrus* (from which the word *paper* derived) rolls of the Chinese are considered as ancestors of modern books.

The concept of books existed in China and in Babylonian way back in 3000 B.C. While the Chinese used papyrus rolls made of bamboo strips, the Babylonians used clay tablets. In Rome, animal skins were used to prepare books. Introduction of paper production advanced the book production. But, absence of easy printing method blocked its mass production. So, earlier books were handwritten and they were called manuscripts.

The Chinese invented a method for printing using wooden blocks in 400 A.D. But, it was not developed enough to print books. Invention of movable metallic types by Johannes Guttenberg revolutionized printing, thereby book production.

Before the invention of movable metallic types, books were expensive and large in size. They were affordable only to the wealthy, aristocratic people like political and religious leaders and business men. Guttenberg's invention changed the situation. Printers could reduce price when books were made available to more people. The first book published using the metallic moveable types was the Bible.

## Characteristics of Books

- Books are portable and compact, and thus have an advantage over other media forms.
- Unlike other print media, books most often deal with a single subject. Thus, we can read books piece by piece for days or weeks with convenient intervals, without losing concentration.
- While newspapers and magazines get old soon due to their time limitations, books remain afresh since they deal with subjects significant for a longer period.
- Unlike magazines and newspapers, books are stored for longer period in public or private libraries.
- Content in the books is in an organized manner so that readers can access to the interested parts easily.



- Books have index which helps reader some sort of navigation from one subject to the other.
- Books are stored for future reference.
- Books are published after adequate verification and research. So, the content of the books is more authentic than that of newspapers and magazines.
- The language level of the books is audience specific or subject specific while newspaper or magazine language is general in nature.

### **Scope of Book Publishing**

The mass production of books certainly revolutionized cultural and thinking pattern by accelerating the exchange of ideas and information among more people. As books are of permanent nature they are considered as repository of knowledge. In the past, contribution of a nation or a person was taken into account based on the number of books produced. Books are creators of culture. Reading is considered one's cultural index.

Books created a special culture in 15<sup>th</sup> and 16<sup>th</sup> century Europe. With the production of books, education through public institution was developed and started to include more people. The book culture paved the way for new cultural elite called writers/authors. Gradually they became recognized public opinion leaders. In any country books were major contributors to national culture and identity. Moreover, books enrich the media sector also by being adapted to movies and documentaries or encouraging the production of various genres in literature like short stories, novels and poetry.

Despite technological advancement, book reading remains the most enduring media using habit. Research results show that books are strongly returning stimulating reading culture even during this age of visuals. In modern time, book production has been a lucrative industry of billions plus dollars.

### **Publishing as an Industry**

Publishing was considered to be an emerging industry after the Industrial revolution. Industrial Revolution spurred the emergence of a new middle class who tend to use books for information and entertainment. To cater to their needs, more publishing houses were started in Europe, America and Asia. Emergence of new knowledge areas like economics, management etc. also urged the rise of publishing houses which produce academic books. Eg. McGraw Hill, Penguin, MacMillan, Harper and Row, Rutledge, Harper Collins. In addition to this, Universities and other higher learning centres also started their publication wings. Eg. Oxford University Press. Book industry is a \$25 billion business in the United States. In India also, it is lucrative business with well organized national and international networks.

### **Publishing in India**

Establishment of printing presses by Christian missionaries in Madras, Calcutta and Goa inspired book publishing in India in 16<sup>th</sup> century. The early books were in English and meant for religious propagation. Considering the public demand, publishers started to launch books of general nature and in vernacular languages.

Emergence of social consciousness after the World War II encouraged reading culture and thus publishing industry. After Independence, education system in the country was rejuvenated and several publishers moved into textbook publishing for academic community. However, since our educational system was molded on western models, major British and American publishers imported academic books to India or started their branches in the country.

### **Government Initiatives**

Indian Government also took initiatives to promote book reading culture starting National Book Development Council (1967), National Book Trust, The Children's Book Trust, The Sahitya Akademi, National Libraries etc.

Kerala Sahitya Academy, Sahitya Pravarthaka Sahakarana Sangham, National Book Stall, Kerala Language Institute, BookMark, Kerala Library Council some of the efforts of Kerala Government to promote book reading culture.

Kerala is a good market for book publishers because of a blooming bilingual readership in the State. Malayalees read both Malayalam and English books. There is an explosion of academic and non-academic publishers in the State in the last decade. DC Books, Paico, Poorna, IPH, Current, NBS are some of the oldest publishing houses in Kerala. Recently leading newspaper firms like Mathrubhumi and Manorama also entered the book industry. Presence of multinational publishers is another trend. Penguin with a tie-up with big media firms launched their operations in the State.

### **Who read books?**

Book reading is a general habit. But, its readers are diverse. Children are avid readers of books and recently publishing industry focuses on children's literature. J.K Rowling's Haripotter series created a new momentum in children's book sector. Government and private agencies publish children's books with an aim of inculcating reading culture in young minds. Central Government's Children's Book Trust of India and Balasahitya Institute of Kerala Government are examples.

Academic community including students, teachers, scholars and researchers are another important segment of book audience. They read both academic texts and fictions.

The third category is general readers ranging from house wives to labors and politicians to businessmen.

### **Types of Books**

Books are categorized according to their content type and target audience. Based on nature of the content books can be categorized generally as fiction and non-fiction. Fictions include stories, novels, poems etc. while non-fictions comprise of academic and reference books.

But, as commercial commodity books are categorized according to their uses and users. Following are the major types of books in modern book industry:

- Trade Books
- Professional Books
- Textbooks
- Paperbacks
- Religious books
- Reference Books
- University-Press Books

**Trade books** include hardbound and paperback books targeting general readers. They are sold at retail outlets. Trade books are categorized as adult books and children's books. Adult trade books include fiction, current non-fiction, biographies, literary classics, hobby books, and books on self-help, popular science, travel, technology etc.

**Children's book** categories range from preschool picture books to young reader books. Drawing and coloring books, cartoon books, comic books, children's fiction are sub categories of children's books.

**Professional Books** target occupational groups such as engineers, doctors, managers, lawyers, technicians etc. These books are not for general readers and are mainly sold through direct mail order to the publishing houses or distributors. Emergence of specialized jobs made the professional book publishing a profitable business.

**Textbooks** are for academic community. They are segmented as elementary-high school books (el-hi), vocational education, college texts, study aids (guides), pocket editions, student editions etc. Because of their mass production, textbooks are low priced books.

**Paperbacks** are low-priced books having cheaper, flexible covers and pages. They lack durability as meant for 'use and throw'. Traditionally, books were produced with hardbound decorated covers. After 1870s paperbacks began to attract middle and working class readers sparking a new reading wave all over the world. Paperbacks became more popular in the second half of 20<sup>th</sup> century.

In America, a new type of paperbacks called **mass-market paperback** is available. They target mass market and sold through drugstores, supermarkets, malls etc unlike traditional paperbacks sold through bookstores. Mass-market paperbacks' content includes fictions and other uncomplicated subjects.

**Religious books** find new life recently with the rise of a spiritual wave across the world. The very purpose of religious books, as name indicates, is propagation. The best-selling book of all time is the Bible, in all its diverse versions. Religious books include holy texts, hymnals and inspirational books.

**Reference books** include encyclopedias, dictionaries, atlases, handbooks, almanacs etc.

**University-Press Books** are non-commercial books aim at academic world. Oxford University Press, Chicago University Press, Harvard University Press are leading University publishers. They focus on both reference books like dictionaries (Eg. Oxford Dictionary) and encyclopedias and academic texts. Universities in Kerala also have publication divisions which publish quality academic texts covering university syllabi.

## Structure of Publishing Organization

Publishing is the production of texts and documents. The production process involves three stages:

- **Pre-Production:** All activities including finding topic, author, market study, negotiation, entry into agreement etc.
- **Production:** Procurement manuscript, editing, proofreading, designing and organization are the processes at production stage.
- **Post Production:** Promotion and marketing are the major post production activities.

### **Organization of Publishing Industry**

A professional publishing organization is structured to cater to these production stages. Thus it includes divisions like

- **Management Division:** This section deals with the overall management of the human resources and infrastructure, fund mobilization and internal and external organization of the publishing firm.
- **Editorial Division:** Editorial division frame the editorial policy of the firm along with other activities such identification of topics, editing, proofreading, style manual preparation, research etc. Creative design of the book is also a part of the editorial team.
- **Production Division :** Printing, binding, packing etc come under the purview of production division.
- **Marketing Division :** This division is to sell the product. Promotional campaigns, publicity, advertisements etc are organized by marketing division.
- **Accounts Division:** They are the money managers. They keep accounts, audit financial transactions, conduct cost analysis and prepare budgets.

### **Technological Development**

Tremendous developments in information technology during the last two decades have had high influence on book production. Introduction of Desk Top Publishing changed the mode of composing book pages and helped to skip steps like type setting, block making etc in traditional book publishing. Desk Top Publishing is the digital page design technique using software like PageMaker, In Design, and Microsoft Word etc.

**Digital publishing** is another revolutionary shift occurred in book business. E-book or electronic book or digital books are paperless books produced electronically and displayed on computer/Ipod/mobile phone screens. Electronic books overcome the disadvantages of paper books. They are cost effective, interactive with multimedia content, easy to duplicate, need less space for preservation and send online across the world within seconds. Being paperless, they are eco-friendly too.

### **Careers in Publishing**

Job opportunities in book publishing are immense. You can be a book editor if you have command over language and general knowledge. Freelance or in-house authors are positions available in the field. Freelance author is free of organizational conditions and doing his job as a hobby or as par time. In-house authors on the payrolls of the publishing firms. They are just like any other salaried staff and conduct research and write books under the direction of the firm.

Graphic designer is an inevitable part of any publishing firm of today as book is considered as a visual product too. But, good artistic sense and command over appropriate graphic design tools are the qualifications. Publication manages and proofreaders are other careers available in the field.



## MODULE IV

### ELECTRONIC MEDIA

#### Objectives

#### This Unit will give an understanding of

- The nature of electronic media and their types
- The origin and growth of radio as a mass medium
- The origin and growth of television as a mass medium
- Latest development in broadcast media sector

#### Introduction

Mass media that use electronic or electromechanical energy for transmission of messages are called electronic media. Major electronic media are radio, television, video and audio records, CDs and DVDs etc. Of these, radio and television messages are transmitted via air waves or radio signals. The process of transmitting messages via radio waves or signals is called broadcasting. The literary meaning of broadcasting is to scatter seed over a broad area rather than in particular place. Possibly because of the ability to spread messages to diverse audiences through radio waves, the technique is called broadcasting.

#### Major broadcasting media are:

- **Telephone broadcasting**, existed between 1881 and 1932 is considered the earliest form of electronic broadcasting..
- **Radio broadcasting** was started experimentally in 1906 and commercially in 1920. It is the mechanism of transmitting audio through the air as radio waves from a transmitter to an antenna and, thus, to a receiving device. Stations can be linked in radio networks to broadcast common programming, either in syndication or simulcast or both.
- **Television broadcasting (telecast)**, started experimentally in 1925, commercially in the 1930s. This technology of airing video revolutionized the modern communication system.
- **Cable Media:** Cable radio started in 1928) and cable television (began in 1932): are the components of cable media. In both, messages are transmitted via coaxial cable, serving principally as transmission mediums for programming produced at either radio or television stations, with limited production of cable-dedicated programming.
- **Satellite television** (from 1974) and satellite radio (from circa 1990): meant for direct-to-home broadcast programming (as opposed to studio network uplinks and downlinks), provides a mix of traditional radio or television broadcast programming, or both, with satellite-dedicated programming.
- **Webcasting of video/television** (from circa 1993) and audio/radio (from circa 1994) streams: offers a mix of traditional radio and television station broadcast programming with internet-dedicated webcast programming.

The original method of transmitting television or radio signals using radio waves, is increasingly being replaced by higher quality digital broadcasting (*television and radio*), transmitted in a digital data stream.

By definition, digital broadcasting is an advanced system of broadcasting radio (DAB or DRB) or television (DTV) in digital pulses rather than waves and which gives improved quality and/or more channels of content. There are currently two quality levels in television, standard definition (SDTV) and high definition (HDTV). Transmitted in binary format, digital television produces good picture quality and digital radio offers high sound quality. Let us have a glance on the technology behind major electronic media: radio and television,

### **Origin and growth of Radio**

**Samuel Morse's** invention of telegraph in 1842 prompted scientists to find out ways to transmit messages over air. In 1895, Italian inventor **Guglielmo Marconi** succeeded in the effort. For further development of the mechanism, he started the Marconi Company in England and started commercial production of radio transmitters for military purpose. Marconi's device was sophisticated by **Reginald Fessenden** and started transmission of sound over radio transmitters, instead of textual signals.

It was US inventor **Lee De Forest** who made radio transmission much clearer with his **Audion** vacuum tube. He also envisaged stations sending continuous music, news and other programmes over radio waves. The idea came to be known as **Broadcasting**. The first radio stations were set up in Pittsburg, New York and Chicago in the 1920s. Following the USA, European countries also started radio stations for broadcasting news and entertainment content. The colonial powers like Britain and France set radio stations in Asian and African countries in the early years of 20<sup>th</sup> century.

### **Radio Broadcasting**

Radio is everywhere as the signals reach every nook and cranny. It is wonder to hear that there are 6.6 radio receivers on average in American homes. Indian officer radio broadcaster All India Radio reaches 98.25 percent of the population of India. Remember that India is the second largest populated country in the world. According to an estimate, there 111 million radio sets in Indian households.

John Vivian, describing the ubiquity of radio, says: " People wake up with clock radios, jog with headset radios, party with boom boxes and commute with car radios. People listen to sports events on the radio even if they are in the stadium." According to Arbitron, a company that surveys radio listenership, more people receive their morning news from radio than from any other medium.

### **Characteristics of Radio as a Mass Medium**

The radio is a powerful mass medium. Unlike other mass media, radio has a lot of advantages, both technical and message wise, to reach maximum number of people.

### **Radio is a cost effective medium.**

Radio sets are not at all a luxury now unlike olden days when radio sets were not affordable for common people. Advancement of technology made radio production and transmission less expensive. Unlike other media, production format is sound which can be produced at a minimum rate.

### **Radio is a Public Medium**

Radio can be accessed by any number of people simultaneously without much technical paraphernalia. Any body can listen to radio as it functions as a background medium.

### **Radio is accessible for the Illiterates**

Literacy is not a prerequisite for listening radio. In developing and under developing countries it becomes a popular medium because of these characteristics. Majority of the population in those countries is illiterate. They shows a special affinity towards radio as they can overcome the deficiency of illiteracy through radio programmes.

### **Radio is a mobile medium**

We can listen to radio while we are moving. As Vivian explained earlier, we can listen to radio while driving car, jogging, walking or doing any job.

### **Radio is a background medium**

Specialty of a background medium is that it can be used while doing other jobs. Housewives listen to radio while preparing food in the kitchen. Given this feature, radio has been now available with home appliances like refrigerator, washing machine etc. as an inbuilt gadget.

### **Radio is an Audio Medium**

Being an audio medium, radio is accessible to the visually challenged also.

### **Radio needs less energy**

Radio consumes very less energy. In that sense it is an environment friendly medium. Since there is not need for power supply for operation radio sets, it gains popularity in remote villages without electricity.

### **Radio is a speedy Medium**

Radio is the fastest medium as it requires no much time for preparation and transmission of news. Instant live broadcasting with less equipment is possible in radio section.

These characteristics extend the scope of radio as a mass medium.

### **Types of Radio Stations**

**Commercial Stations:** Stations under this category support themselves financially by selling time on their airwaves to advertisers. In America, vast majority of stations come under this category whereas in India, most of the stations are government funded ones under the umbrella of Akashvani.

**Non-Commercial Stations:** Non-Commercial Stations do not receive financial support from advertisers in the sense of airing commercials. They are normally funded by the governments. In some countries like America, donations from private foundations and organization are the major sources of income of non-commercial stations.

**AM and FM Stations:** This categorization is purely based on the type of waves used for transmitting radio messages. Both AM and FM radio stations transmit a carrier wave that is some changed or modulated to carry audio signal such as music or voice. With AM (Amplitude Modulation) radio, the amplitude or strength of the carrier wave's vibration fluctuates with the sound. With FM (Frequency Modulation) radio, the strength of the carrier wave remains constant, and instead it is the frequency or number of vibration within the wave that changes based on sound.

### **Structure of a Radio Station**

A radio station has four distinct divisions under a general manager. The sections are:

**Management Department:** takes care of the overall administration of the station. It has internal and external administration responsibilities. The department is further divided under Business manager, Accounting Manager, Human Resource Manager, Public Relations Manager, Promotion Manager etc.

**Programming Department :** This is an important component that specially deals with the media related responsibilities of the station. This can be again segmented as News Programmes and Non-news programmes or as news and operations

**Programme Director:** He/she is the in charge of all works related to programme planning, research, production and permitting for transmission. There are two types of staff under Programme Director : The first category include On air talent, DJs, Reporters who are normally not on the regular payroll of the station. They are invited for specific purpose. Some radio stations which focus on news programmes appoint reporters on permanent basis. The other category includes Production Director, Music Director, Sports Director, Programme Executives who are directly responsibility for the production and supervision of the segment allotted to them.

**Engineering Department:** The technical aspects of the station are handled by this department under the supervision of Chief Engineer and Asst Engineers

**Sales Department:** It is another important section which monitor and ensure financial flow to the station. The Sales Department is organized on the basis of the business model followed by the station. Normally, commercial broadcasting stations may have Account Executive, Advertisement Managers, and Retail Sales Representatives in the Sales Department.

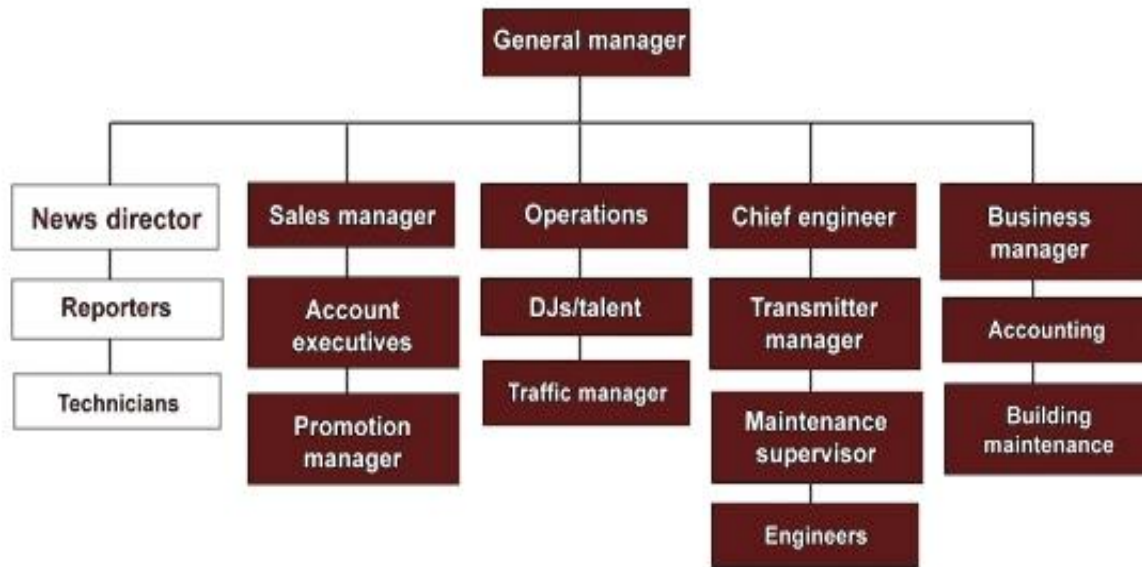

## Radio practices

For the better understanding of the practical aspects of radio production one should know about the programme types, their characteristics, qualities of programme producer, and those who work behind the production process.

## Radio Programmes

Radio programmes can be categorized into two: News and Non-News (Entertainment) Programmes.

Policy of the country or the individual organizations determines the nature of their programme mix. In the United States of America, radio is more an entertainment medium than a news channel. In India, it has a perfect mix since the mission of the AIR requires such a policy given the socio-cultural settings in India.

## News

News is important because it keeps us informed as to what is happening in our own community and what is happening in other communities which impinge upon our own. It satisfies our curiosity and concern and it provides us with basic facts which enable us to make up our minds and so join in the general discussion which leads to community action.

## News bulletin

News bulletins have assumed increasing importance in radio broadcasting in recent years. In the early days of radio there was seldom more than one bulletin a day and it was broadcast after the evening newspapers reached the streets and had been sold. As radio stations built up their own news staffs the number of bulletins increased. Many stations today have several long bulletins interspersed with hourly or even half-hourly news summaries.

## **Newsreel**

It is more usual to separate comment from the news by including it in news talks and newsreels. The daily newsreel of fifteen or more minute's duration is a popular form of news broadcasting. It contains eye-witness accounts, extracts of speeches and reports of other events, commentaries, short talks and interviews in much the same way as a newspaper includes pictures and feature articles.

## **Documentaries**

The documentary programme is a story of something. It is generally between 15 and 60 minutes in length-the actual length is usually related to the size of the subject and the way in which it is treated. An industrial or agricultural development may warrant up to 30 minutes, while a historical re-enactment or archive programme (that is one using previously recorded historical material) may require 45 or 60 minutes.

## **Magazine Programme**

The regular radio magazine programme, derived from the newsreel, is a useful outlet for a great deal of informational and soft news material which cannot be programmed elsewhere. Magazine programmes vary in length; usually either 15 or 30 minutes. They consist of short talks, interviews, on-the-spot reports and eye-witness accounts of events, commentaries, music and sometimes poetry and short stories.

## **Talk Programmes**

Talks were the earliest form of spoken word broadcasting. They are the simplest form and can still be the most effective. A good radio talk, well constructed and well delivered, can sparkle like a gem against the back ground of other programmes which make up the broadcast day. It can have all the authority of the printed word coupled with the warmth which comes from person to person contact.

## **Talk**

The radio talk is neither a lecture nor a public address. The audience does not have to stay and listen nor can it see the speaker and be attracted by the way he uses his hands and his eyes. Everything in a radio talk has to be carried in the words: the familiar words we all use.

The best of radio talks is a friendly chat built around one subject. It is a spoken composition and like any composition it needs a unified structure: it has a clearly defined beginning, middle and an end. The words it uses are the action-words of everyday speech. It introduces the subject in an ear-catching way, explains it simply, develops its argument and then summarizes what it has said

## **Interview**

The radio interview is a lively variation of the talk. It considerably expands the potential pool of talks' contributors by bringing to the microphone people who have something to say but who cannot write talks or are too busy to do so. It is a popular form of talks broadcasting as most of us like to hear-or overhear-other people talking, and it is a very useful form particularly in countries where there are many language There are several kinds of radio interview but essentially they can all be classified under two headings:



- The personality interview which seeks to bring out the personality of the interviewee and tells us something about his life and ideas.
- The information interview which seeks out facts.

### **Discussion**

The discussion programme provides a platform for the exchange of ideas. The ideas may be important ones which concern us as individuals, as members of a community or as nationals of a country; or they may be ideas intended simply to entertain us. The discussion may be serious or light-hearted, but its purpose is always to set us thinking.

### **Entertainments**

Light entertainment is a rather loose term used by many stations to cover a wide field of programming: book and short story readings; serialized drama, particularly light and humorous drama; variety programmes featuring light musical entertainment, comics, community singing; some types of listeners' letter programmes; quizzes and panel games

### **Music**

Music fills by far the greater part of the broadcast day. The general tone and character of a station's music does more to establish the image of a station than any of its other activities.

It is in the nature of all of us to enjoy music. We enjoy it for its rhythms, its melodies and its harmonies. Some music is predominantly melodic-it has memorable tunes-while other music is dominated by its harmonic structure-the way in which notes and groups of notes make pleasant sounds when heard together. European music gives a great deal of emphasis to melody while Indian and Arabic music regards harmony as being more important.

### **Classification of Music**

Some authorities classify music under four headings:

- Primitive music-music with no written score, no known composers and of ancient origin.
- Folk music-also with no written score but sometimes with known composers; generally of more recent origin.
- Popular music-sometimes with a written score, composers frequently known, marked melodies.
- Art music-a written score, composers invariably known, a classical structure.

### **Radio Drama**

There are three methods of presenting radio plays: (a) as completely self-contained plays of 30, 45 or 60 minutes in length; (b) as serial dramas of 15 or 30 minutes in length in which the action goes forward from one episode to another; (c) as series drama, each broadcast generally lasting for 30 minutes and completing one whole episode of a continued story; the principal characters reappear in new situations in each new drama in the series.



## Radio Advertising

A station which carries advertising obtains it either directly from an advertiser or indirectly through an agency representing an advertiser. Where an account is obtained through an agency the agency prepares the advertisements- called copy or commercials-and listens to the station to make sure they are properly broadcast and at the times contracted for. Where a station obtains an account direct from the advertiser the station generally writes the copy.

## Writing Radio Scripts

Radio writing differs from writing for publication imprint because the medium is different. Broadcasting is a form of living publication; it is not static but something which moves forward in present time. This calls for a different approach-a difference in style.

The reader of a newspaper or a magazine can select or reject paragraphs or whole stories as the fancy takes him. When he is not clear in his understanding of the author's meaning he can always re-read. This is not so of radio. The listener has to take everything as it comes or not listen at all. When he is unclear he has *no* means of referring back to clarify a point. A radio-script writer must therefore seek to hold the listener's rapt attention and go to considerable pains to ensure that the meaning is clear and understandable at every stage of a talk or story as it progresses. Another distinctive characteristic of radio writing is that things heard *on* the radio appear to the listener to be happening now. A broadcast is not a report of something past and gone-even the act of news reading is something taking place at the same time as it is heard. Above all radio writing is writing for the spoken word and everyday speech should be the guide to the words we use and the manner in which we use them. In talking with one another we use familiar words. We assemble what we have to say in short phrases and seldom put *our* ideas together in the kind of lengthy paragraphs which we may write. We put forward our ideas directly, not cluttered with small details nor involved in rambling parenthesis. From these characteristics of radio writing we may deduce a series of rules.

## Tips to write good radio scripts

Unesco Document on radio production advanced the following suggestions to ensure the quality of radio scripts.

- Use words which are in everyday use and are readily understood by the majority of people. This does not mean to say that we should use only simple words to the exclusion of all others. Where it is necessary to use an unfamiliar word it should be explained or enlarged upon in a short explanatory sentence or a short parenthesis.
- Sentences should be kept short. But we must avoid a series of short staccato sentences which would make a speech sound jerky. Variety in sentence length makes a speech sound interesting. In general, however, the length should tend to be short rather than long. A sentence should never be longer than the number of words we can easily carry *on* a breath.
- Avoid dependent clauses and clumsy inversions. Dependent clauses and inverted clauses are quite common in written matter but we seldom use *them* in normal speech. For example we may write: 'Longing for a cold drink, as he had walked many miles that day

under a hot sun, Festus walked into the first bar he came to in the village.' In radio style the idea may be better expressed this way: 'Festus was thirsty. He had walked many miles that day and the sun had been agonizingly hot. He entered the first bar he came to in the village.'

- Use descriptive words where possible but use them with care. The radio listener has only words to guide *him* and to sketch pictures which he would otherwise see with his eyes. The use of a descriptive word helps *him* to see the picture. In the example above 'agonizingly hot' says more than simply 'Under a hot sun'. But descriptive words can be over-used if a script is filled with them. Descriptive words are better than figures where it is possible to use them- (twenty minutes walk away' says more to the listener than ca mile away'.
- Speech has rhythm and speech rhythms should be kept in mind when writing radio script. A radio script should *flow* with the fluency of poetry. It helps to carry the listener along and it holds his attention. Some of the best of radio dramas and radio documentaries have been written by poets who have a flair for the rhythms of language.
- *A radio script should display an element of 'nowness'*. Whatever the broadcast, as far as the listener is concerned, it is happening now. It is an immediate and a personal experience. This should always be kept in mind when writing for radio. The choice of viewpoint from which a script is written, the choice of words, the author's approach and the enthusiasm with which he writes all have a bearing on the sense of immediacy.

### **Producing Radio Programme**

As per the guidelines of the Unesco document which details how to produce profession radio programmes, a radio producer should have: a good grasp of the language in which he works so that he can edit scripts and advise speakers on correct pronunciation, a manner which wins the co-operation of artists, a *skill* in instructing and directing other people at the microphone, a good general knowledge and an interest in community affairs, a sense of responsibility, the ability to take the initiative and the enthusiasm to experiment, a creative turn of mind and a flair for showmanship, an ear for sound and the ability to conceive ideas in terms of sound, a thorough knowledge of the technical facilities and of the techniques of radio, a specialist interest. The outline makes no reference to educational qualifications although some are implied. On this matter it is worth noting a Unesco recommendation regarding the recruitment of broadcasting personnel: 'Present standards are suitable but possession of certificates should not be mandatory. The emphases should be on talent, creative ability and an aptitude for broadcasting.'

### **Origin and growth of Television**

By definition, television broadcasting is the transmission of visual images, generally with accompanying sound, in the form of electromagnetic waves that when received can be reconverted into visual images. On January 23, 1926, **John Logie Baird** of Scotland gave the world's first public demonstration of a mechanical television apparatus to the members of the Royal Institution at his laboratory. These were images of living human faces, not outlines with complete tonal gradations of light and shade. On April 7, 1927 Bell Telephone Labs and AT&T

give a USA public mechanical television demonstration over both wire and radio circuits. Pictures and sound were sent by wire from Washington D.C., to New York City. However it took further eight year for the beginning of practically feasible television broadcasting.

Between 1935 and 1938, the Nazi government under Adolph Hitler in Germany operated the world's first regular television service, with propaganda broadcasts to specially equipped theatres. It was after the end of World War II in 1946 that commercial television came into being in the United States. In the same year, **Peter Goldmark** introduced color television system. His system produced color pictures by having a red-blue-green wheel spin in front of a cathode ray tube. In 1948, Cable television is introduced in Pennsylvania as a means of bringing television to rural areas. Cable television is the process of sending TV signals to subscribers through wires or fiber optic cables. In 1950s, television gained widespread acceptance in the United States and in some European countries.

The development of **satellite television** in the 1970s allowed for more channels and encouraged businessmen to target programming toward specific audiences. It also enabled the rise of subscription television channels, such as **Home Box Office** (HBO) and Showtime in the U.S., and Sky Television in the U.K. **Satellite transmission** means sending television signal using satellites in the orbit. Satellite transmission paved the way for **Conditional Access System**, a digital mode of transmitting TV channels through a set-top box (STB). The transmission signals are encrypted and viewers need to buy a set-top box to receive and decrypt the signal. **Direct To Home** (DTH) service was also made possible with the help of satellite transmission technology. As of 2010, over 500 TV Satellite television channels are broadcast in India. This includes channels from the state-owned Doordarshan, News Corporation owned STAR TV, Sony owned Sony Entertainment Television, Sun Network and Zee TV. Now, Direct To Home service is provided by Airtel Digital TV, BIG TV owned by Reliance, DD Direct Plus, DishTV, Sun Direct DTH etc.

The latest incarnation in television technology is **Internet Protocol Television** (IPTV) in which audio and video are transmitted using internet file transmission protocols and viewers watch programmes on computer screens instead of television sets.

## **Television Broadcasting**

Television is one of the most popular inventions of the last century. Every day we spend hours with television. It is a reality that we cannot imagine a day without television consumption. Our imagination of the world is formed with television.

According to the A.C. Nielsen Company, a well known research organization, the average American watches more than 4 hours of TV each day (or 28 hours/week, or 2 months of nonstop TV-watching per year). In a 65-year life, that person will have spent 9 years glued to the tube. Percentage of households that possess at least one television: 99 Number of TV sets in the average U.S. household: 2.24. Percentage of U.S. homes with three or more TV sets: 66 .Number of hours per day that TV is on in an average U.S. home: 6 hours, 47 minutes . From this statistics we get how television influences man. This is the case of the United States of America. The situations in other countries are also no different.

## **Characteristics of Television as a Mass Medium**

- **Audio Visual Medium**

Radio is audio medium while television is audio visual, means it carries moving pictures and sound.

- **Live Medium**

With these magical features of television, it enables us to view the events any where in the world live while sitting in our drawing rooms.

- **Domestic Medium**

Film is also an audio visual medium. It is not live. And, for watching films, we have to theatre. Most of us watch television in home environment because this medium is conceived to be so. So, it is called a domestic medium.

- **Popular Medium**

Literacy is not a barrier in watching television while newspaper reading requires literacy. Any illiterate can get information and entertainment from television. In that sense, it is really a popular medium any type of people can use.

- **Transitory Medium**

You can read today's newspaper in the evening or in the morning. But, television programmes are to be watched while they are telecast. Television has not archival facility. So, it is called as a transitory medium. Radio has also the same characteristics.

- **Expensive Medium**

In every term, television is expensive. Television set is costlier than a radio set or newspaper. Setting up a television station involves millions of rupees. Transmission facilities and programme production also require a lot of money.

- **Air wave delivery**

Unlike newspapers which delivered door to door, television messages are transmitted through air waves. So, it does not have complicated distribution system.

- **Good for documentary information**

Like any other medium, television can also be used for information dissemination. With its audio-visual capacity, television is more apt for providing documentary information as we can detail functions, process and other details in a 'live' mode.

## **Types of Television Transmission Systems**

Technological advancements define and redefine the mode of delivery of television messages. The prominent ways of television transmission are given below.

## **TV Broadcasting**

It is over-the air transmission of audio visual signals from towers owned by television stations on frequencies allotted to them by Ministry of Communication. People can receive the signals without charge by simply turning on a television on a set. Sometimes, we need an antenna for receiving signals.

## **Cable TV**

By definition, Cable TV is the process of sending TV signals to subscribers through a wire. Transmission of messages via cable was invented in 1929 and commercially utilized in 1940s. Cable television system was popularized in 1970s in America. The earliest cable systems were, in effect, strategically placed antennas with very long cables connecting them to subscribers' home sets. Because the signal from the antenna became weaker as it traveled through the length of cable, cable providers had to insert amplifiers at regular intervals to boost the strength of the signal and make it acceptable for viewing. With invention of optical fibers, it has been easy to transmit signal in a speedy way without losing picture quality.

Today, cable systems deliver hundreds of channels to some millions of homes, while also providing a growing number of people with high-speed Internet access. Some cable systems even let you make telephone calls and receive new programming technologies!

## **Satellite Transmission**

It is transmission of television signals through satellites put in the orbit for communication purpose. It enables the households to receive signals directly from the satellites using dish antennas. This is also called **Direct to Home (DTH)** Satellite Services. It is digital technology that delivers up to 150 channels to a plate-sized receiver on subscriber's house. For this, we have to use a set box to convert digital signals received by the antennas into audio visual format.

## **Home Video**

It is not related with television transmission process. It refers to the pre-recorded video either sold or hired for home use. Most of the content are of entertainment nature. Educational documentaries are also available as part of this method. Earlier VHS/Betamax video cassettes played in Videocassette Recorders (VCR) were available. Now, these are now replaced with VCDs, DVDs( Digital Versatile Discs), USB Drives and Blue Ray Discs.

## **Structure of a Television Station**

A television station has five major sections under the General Manager. News Section, Sales Section, Programming Section, Engineering Section and Business Section. Who comes under each section is detailed in the graph given below.

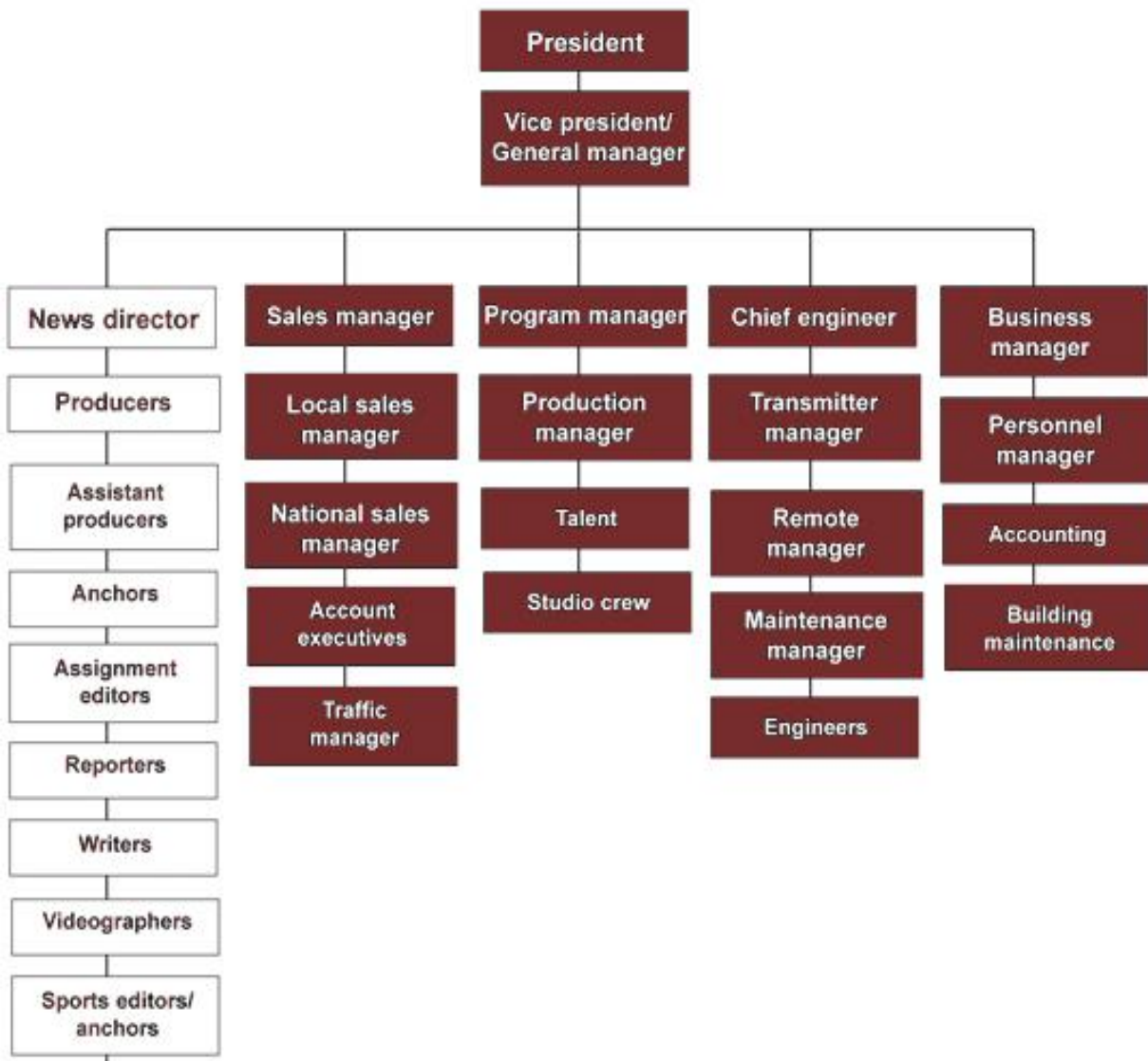

**The General Manager:** At a television station, the general manager oversees departments. The GM is in charge of guiding the people who run the individual departments. Those departments normally include: news, production, sales, promotions and engineering. All departments impact how a news product is presented on the air.

**The news department** gathers, writes and edits the stories for a daily newscast. News departments consist of several job titles, including news director, assignment editor, executive producer, producers, reporters, anchors and photographers. Each position is important to providing quality programming. ( job titles may vary according to the size and policy of the station)

**The sales department** generates revenue for the station by getting companies to buy commercial spots.

**The programme production** department puts on air what the news department creates. Production departments often include a director, technical director, audio operator, master control operator and camera operators.



**The engineering department** takes care of the technical aspect of a newscast and the station itself. When something breaks, they are the people employees in other departments call on.

**The Business department** works with companies that buy commercials, creating a concept for the commercial and editing it to create an on-air product. Employees in the promotions department also create commercials to advertise the station.

### Careers

News Director, Assistant News Director, Managing Editor, Executive Producer Assignment Editor, News Producer, News Anchor, Weathercaster (Meteorologists), Sports Anchor, News Reporter, News Writer, News Assistant, Sports Reporter, Photographer, Video Editor, Graphics Specialist, Internet Specialist are some of the careers available in the television journalism sector.

### Film

Like television, film is also an audio visual medium. It is the most popular medium of the last century. The technology behind the cinema was invented by Lois Lumiere and his brother Auguste Lumiere who are famously known as Lumiere brothers. But, their invention of moving picture technique was just an extension of photography. Their equipment called 'cinematographe' was a compact, portable machine with an inbuilt camera and projector. They exhibited actualities in life like arrival of a train, workers leaving a factory and such real events with their equipment.

Georges Melies of France utilized the motion picture technology to tell stories and to show magical events, fantasies and dream like 'events' using elaborated sets and editing techniques. It was with the efforts of Melies that cinema became a mass medium. His film *Voyage to the Moon* produced in 1902 was famous for its novelty in treatment.

### Growth of Cinema

After exploration of this potential of the medium, film started to grow as an independent cultural/entertainment industry, attracting millions of people world over. Realistic treatment of the stories was the narrative styles of earliest feature films. Pioneers like Eisenstein, Pudovkin, both are Russians, revolutionized cinema with their attractive realistic style of narration and editing techniques. Gradually, as an active medium with mass support, film began to develop its own language using the potential of the mixing of verbal and non-verbal communication methods.

Innovations like sound recording, sophisticated cameras, editing techniques, exhibition pattern, production styles and narrative methods made cinema more impressive and attractive. Earlier history of cinema can be divided into **Silent Era** and the **Era of Talkies**. Silent Era refers to the period during which films were produced without sound due to the absence of adequate technology. The power of the cinema during the silent era was the power of their stories. Talkies mean the films with sound.

Another categorization of the history of cinema was on the basis of the colour of visuals. Earlier films were produced in **Black and White** films. **Colour films** revolutionized the medium as the audiences were hugely attracted to colour film as it provided them with a colorful real life visual experience.



## **Cinema as a mass medium**

Film influences society more than any other medium. The impact of film is easily visible in the popular culture. The fashion and life styles of the masses are defined by the films. While news media provide people with information, films entertain them. Because of this nature of the medium, film is called as a cultural medium.

More than a mass medium, film is an industry also. It deals with billions of dollars everyday. Film industry involves a lot of expensive technology and huge financial transactions. Moreover, films were and still are used as political tools, especially for propaganda. Adolph Hitler's propaganda films during the world war were the best case in point. Now, cinema is more business than a political tool. During this time of globalization, films cross borders and function as transmitters culture and method of financial flow.

## **Cinema as an Industry**

The **film industry** is an umbrella term to denote the technology, economics and human resources in film business. It includes production houses/companies, studios, production techniques like cinematography, acting, editing, and screenwriting, directing and marketing methods like distribution, promotion and festival organizations.

In terms of technical quality and financial quantity, film industry of the United States of America is the biggest one in the world. Hollywood is the dedicated centre of film production in the USA. With its multi-lingual character and tremendous mass support, Indian film industry is also reckoned with one in the world. Other major countries which excel in film production are China, Egypt, Italy, Japan, France, UK and Iran. Iran is very famous for the artistic value of Iranian cinemas.

## **Types of Films**

Films can be mainly categorized in to two: **Documentaries and Feature Films.**

**Documentaries** are realistic films based on a specific topic and its shed light into various aspects of the subject matter. It is informative/educative in nature. It is a non-fiction narrative without actors. Typically a documentary is a journalistic record of an event, person, or place. On the other hand, feature films are movies of at least 40-45 minutes (2 reels) long intended for theatrical release.

**Film Genres:** Apart from this division in general nature, films can be segmented according to the treatment of the content. Following are the major genres of films. Comedy, Drama, Romance, Action/Adventure, Mystery/Suspense, Westerns, Horror, Fantasy, Science Fiction, Musicals, Film noir are of some the types of films.

**Major Players in Movie Industry:** Warner Brothers, Walt Disney, Columbia Picutres, Twentieth Century Fox, Paramount and Universal are the major tycoons who rule the movie industry in the world.

## **Careers in Film**

Producer, director, screenplay writer, lyricist, music composer, actors, make-up artist, sound recordist, film editors, director Art Director, Cinematographer, Director of Photography, Property Master, Camera Operator, Camera Loader, Focus Puller, Electrician, Equipment operator, , Dolly Grip, Best Boy (Chief Assistant), Foley Artist, etc.

## MODULE V

### NEW MEDIA

#### Objectives

After completing this module, you will get a basic understanding of

- The Internet and its evolution
- New media and the characteristics
- Social media and other web based communication formats
- How to write for the web
- Technical writing

#### History of the Internet

The Internet has revolutionized the computer and communications world like nothing before. The invention of the telegraph, telephone, radio, and computer set the stage for this unprecedented integration of capabilities. The Net (both the World Wide Web and the Internet- *Note the difference between the Internet and the World Wide Web: The Internet is a computer network consisting of a worldwide network of computer networks and cables that use the TCP/IP network protocols to facilitate data transmission and exchange. The World Wide Web is a computer network consisting of a collection of internet sites that offer text, graphics, sound and animation resources through the hypertext transfer protocol.*) is fundamentally a tool to allow people around the globe to communicate with each other. Until the early 1990s, the Internet was simply a network of computers used to transmit government data and enable academic research and conversations. With the advent of the World Wide Web by Tim Berners Lee in early 1990s and online subscription service providers such as America OnLine (AOL), CompuServe and Prodigy, the Internet traffic began its exponential upswing.

According to Silicon Valley Historical Association, following the brief time line of the growth and evolution of the Internet

**1957 :** The USSR launches the first satellite, Sputnik. To compete against the USSR's success at launching the first satellite, the United States Department of Defense creates the Advanced Research Projects Agency (ARPA). ARPA is responsible for the development of new technology for use by the military.

**1969 :** The first host-to-host Advanced Research Projects Agency Network (ARPANET) connection is made on October 25, 1969, between the University of California at Los Angeles, and the Stanford Research Institute, Inc. (SRI) in Menlo Park, California. ARPANET is the world's first operational packet switching network and the core network of a set that came to compose the global Internet.

**1972 :** ARPANET begins to be used for communicating email.

**1973 :** The term "Internet" begins to be used.

**1976 :** Comet, the first commercial email software, is offered by the Computer Corporation of America for \$40,000.

**1981** : Al Gore coins the term for the Internet “The Information Superhighway.”

**1990** : The phrase “World Wide Web” is coined by Tim Berners-Lee.

**1992** : Internet registration begins for .com, .net, .org, .edu, and .gov.

**1993** :The Internet takes off as part of the world’s fastest growing information network and the MOSAIC Web Browser is born on the University of Illinois at Urbana–Champaign campus.

The World Wide Web is developed in CERN, the Institute for Particle Physics in Switzerland.

**1995** : The independent programming language, JAVA, is created by Jim Gosling at Sun Microsystems. And, Yahoo! is founded in Santa Clara, California, and provides a web search engine, email service, mapping and more.

**2001** : Wikipedia is launched.

**2004** : Facebook is founded in Cambridge, Massachusetts.

**2005** : YouTube launches.

**2006** : Twitter is founded in San Francisco, California.

**2011** : Twitter and Facebook are the primary means of communication for the Arab Spring

### **Defining New Media**

New media can be defined as interactive forms of communication that use the Internet, including podcasts, blogs, vlogs, social networks, text messaging, wikis, virtual worlds and all other computer aided communication formats available online. New media makes it possible for anyone to create, modify, and share content and share it with others, using relatively simple tools that are often free or inexpensive. New media requires a computer or mobile device with Internet access.

New media tools can:

- Connect people with information and services.
- Collaborate with other people –including those within their organization or community.
- Create new content, services, communities, and channels of communication that help people deliver information and services.

### **Characteristics of New Media**

Over the traditional media like newspapers, television and radio, new media have the following advantages:

- Capacity to overcome the lack of time and space though it is limited with screen size, downloading time, server capacity etc.
- Flexibility: New media can handle variety of forms for the information it presents – words, pictures, audio, video, and graphics.
- Immediacy: New media can deliver information immediately, often as events are unfolding.
- Immediacy is variety : New media can cover different aspects of news at a time

- Hypertextuality : New media can connect one format of information with other formats and sources of information through hyperlinks.
- Interactivity: New media have human-machine communication system.
- Multimediality: Unlike traditional media, new media can contain various types of media format on a single platform. We can watch television and listen to radio, and read newspapers on a webpage.
- Cost effective. Compared to other media, webpage production is cost effective and environment friendly.
- Extended Access: We can get access to the web or new media sources wherever we are.

### **Social Media Networks**

Andreas Kaplan and Michael Haenlein define social media as "a group of Internet-based applications that build on the ideological and technological foundations of Web 2.0, and that allow the creation and exchange of user-generated content. Kietzmann says that social media employ mobile and web-based technologies to create highly interactive platforms via which individuals and communities share, cocreate, discuss, and modify user-generated content. It introduces substantial and pervasive changes to communication between organizations, communities and individuals.

Different types of social media include collaborative projects such as Wikipedia, blogs such as Blogger, social networking sites like Facebook, content communities like Youtube, and virtual worlds like Second Life . As of 2012, social media has become one of the most powerful sources for news updates through platforms such as Facebook, Blogger, Twitter, WordPress, LinkedIn, Pinterest, Google+. Tumblr, MySpace and Wikia.

Social media differentiates from traditional/industrial media in many aspects such as quality reach, frequency, usability, immediacy and permanence The internet usage effects of social media as of 2012 are, according to Nielsen, that internet users continue to spend more time in social media than any other site. At the same time, the total time spent on social media in the U.S. across PC and mobile devices increased by 37 percent to 121 billion minutes in July 2012 compared to 88 billion minutes in July 2011.

Social media technologies take on many different forms including magazines, Internet forums, weblogs, social blogs, microblogging, wikis, social networks, podcasts, photographs or pictures, video, rating and social bookmarking. Kaplan and Haenlein created a classification scheme with six different types of social media: collaborative projects (for example, Wikipedia), blogs and microblogs (for example, Twitter), content communities (for example, YouTube), social networking sites (for example, Facebook), virtual game worlds (e.g., World of Warcraft), and virtual social worlds (e.g. Second Life). Technologies include: blogs, picture-sharing, vlogs, wall-postings, email, instant messaging, music-sharing, crowdsourcing and voice over IP, to name a few. Many of these services can be integrated via social network aggregation platforms. Social media network websites include sites like Facebook, Twitter, Bebo and MySpace.

*(Kaplan Andreas M., Haenlein Michael, (2010), Users of the world, unite! The challenges and opportunities of social media, Business Horizons, Vol. 53, Issue 1).*

## **Blogs**

A blog is basically a journal that is available on the *web*. It is derived from the term 'Web Log'. The activity of updating a blog is "blogging" and someone who keeps a blog is a "blogger." Blogs are typically updated daily using software that allows people with little or no technical background to update and maintain the blog. Postings on a blog are almost always arranged in chronological order with the most recent additions featured most prominently. It is common for blogs to be available as RSS (Really Simplified Syndication) feeds. [www.blogspot.com](http://www.blogspot.com), [www.wordpress.org](http://www.wordpress.org) are some of the free blog hosting sites.

## **Vlogs**

A video blog or video log, sometimes shortened to vlog is a form of blog for which the medium is video, and is a form of web television. The word derived from the term Video Web Log. On January 2, 2000, Adam Kontras posted a video alongside a blog entry aimed at informing his friends and family of his cross-country move to Los Angeles in pursuit of show business, marking the first post on what would later become the longest-running video blog in history. (*Kaminsky, Michael Sean (2010. Naked Lens: Video Blogging & Video Journaling to Reclaim the YOU in YouTube. Organik Media, Inc)*)

## **Podcast**

A podcast is a type of digital media consisting of an episodic series of audio radio, video, PDF, or ePub files subscribed to and downloaded through web syndication or streamed online to a computer or mobile device. The word is derived from "broadcast" and "pod" from the success of the iPod, as podcasts are often listened to on portable media players. ([en.wikipedia.org/wiki/Podcast](http://en.wikipedia.org/wiki/Podcast))

## **News portals**

A web portal is a web site that brings information together from diverse sources in a uniform way. Usually, each information source gets its dedicated area on the page for displaying information (a portlet); often, the user can configure which ones to display. Apart from the standard search engines feature, web portals offer other services such as e-mail, stock prices, information, databases and entertainment.

Portals provide a way for enterprises to provide a consistent look and feel with access control and procedures for multiple applications and databases, which otherwise would have been different entities altogether. Hence, news portal is a web portal dedicated to disseminate news and related information. Normally, news portals are managed by media organizations and media professionals.

## **Basics of Web Writing**

Before getting down to writing for the web, we should have an understanding of how audience use the web content. Users do not read on the Web; instead they scan the pages, trying to pick out a few sentences or even parts of sentences to get the information they want and users do not like long, scrolling pages: they prefer the text to be short and to the point. Similarly, users detest anything that seems like marketing fluff or overly hyped language and prefer factual information, because they can easily search for the alternative just with a mouse click.

Taking these factors into account, the following principles are to be kept in mind while writing for the Web.

- Text Should be concise: If websites are too wordy, it's hard to read a lot of text on the screen. It is better to have condensed information that's no bigger than one screen.
- Text Should be scannable : We ensure the elements that enhance scanning include headings, large type, bold text, highlighted text, bulleted lists, graphics, captions, topic sentences, and tables of contents.
- Bulleted items : Using bulleted items will help readers to easily locate the facts they search for.
- Users Like Summaries and the Inverted Pyramid Style Every reader tend to read a summary and then go to the article if s/he is interested.
- Hypertext is well-liked: Hyper texts and links help users to navigate from one page to other and one site to the other. Creative use of hyperlinks the crux of the success of the web. While writing for the web, writer should keep the hypertextual nature of the content.
- Graphics and text should complement one another : Graphics that add nothing to the text are a distraction and waste of time . A graphic is good when it relates to the content, but many are just trying to be flashy.
- Users want to get their Information quickly. So, the content should be clear and well organized with a logical transition.
- Credible content creation : Credibility is an important issue on the web . Accurate and fair good content with no grammatical errors increase believability of the content. External links, fresh materials rather than the older ones, can increase credibility. People tend to trust web sites that are more usable. Trust is especially critical for web sites that sell products and services
- Humor should be used with caution

### **Technical Writing and Documentation**

The Society for Technical Communication (STC), a professional society for the advancement of the theory and practice of technical communication defines technical writing as a broad field including any form of communication that exhibits one or more of the following characteristics: (1) communicating about technical or specialized topics, such as computer applications, medical procedures, or environmental regulations; (2) communicating through technology, such as web pages, help files, or social media sites; or (3) providing instructions about how to do something, regardless of the task's technical nature.

Every day we read a lot of content written by technical writers. Help menu on our computer screen, user manual we get along with the mobile phone we purchase, installation guide of our printer are written by technical writers.. In addition to these, technical writers write product release notes, product troubleshooting guides, tutorials, installation guides, marketing documentation, e-learning modules, web content, legal disclaimers, business proposals, and white papers. In the present day corporate world, technical writing is a high profile handsomely paid job



Good technical writing clarifies technical terms, adding useful information that is clear and easy to understand for the intended audience. Technical writers usually begin their work by learning the purpose of the document that they will create, gathering information from existing documentation and from subject-matter experts and write documents and publish them after required editing and vetting. A good technical writer needs strong language and teaching skills and must understand how to communicate with technology.

### **References**

- Alred, Gerald J. Handbook of Technical Writing, Sage, New Delhi
- Arlington, VA, The First Amendment Handbook.: The Reporters Committee for Freedom of the Press, 2003.
- Campell, Richard : Media and Culture, An Introduction to Mass Communication, 2<sup>nd</sup> Edition, Bedford/St.martine's, Boston.
- Dominick, Joseph R: The Dynamics of Mass Communication, Harper and Row, New York
- Lister, Martine: New Media: A Critical Introduction, MIT Press
- Mamer, Bruce : Film Production Techniques, Thomson Warsworth, Singapore.
- McQuil, Denis: McQuil's Mass Communication Theory, Vistaar Publications, New Delhi.
- Turow, Joseph: Media Today: An Introduction to Mass Communication, 3<sup>rd</sup> Edition, Routledge, London, 2010
- Vivian, John: The Media of Mass Communication, 5<sup>th</sup> Edition, Allyn and Bacon, Singapore, 2008
- [en.wikipedia.org/wiki](http://en.wikipedia.org/wiki)

\*\*\*\*\*